

ELETTROPOMPE CENTRIFUGHE MONOBLOCCO SECONDO EN 733

in ghisa

Pompe centrifuge normalizzate derivate da EN 733 (ex DIN 24255).

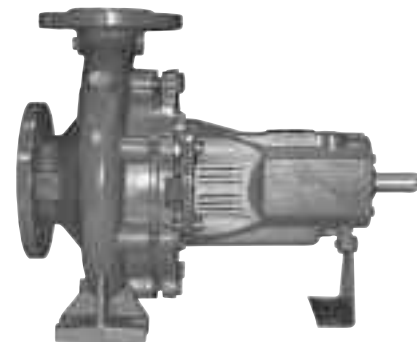

APPLICAZIONI

- Alimentazione di acqua in impianti civili, agricoli ed industriali
- Pressurizzazione
- Impianti antincendio, di riscaldamento e condizionamento
- Movimentazione di liquidi industriali
- Impianti di depurazione, acquedotti ed irrigazione

PECULIARITÀ TECNICHE

- Costruzione robusta
- Possibilità di utilizzo nei gruppi antincendio
- Possono essere inserite in complessi macchinari ad uso industriale

DATI TECNICI

- Portata massima: 2 000 m³/h
- Pressione massima: 147 m
- Pressione max d'esercizio: 16 bar
- Temperatura del liquido: -20°C ÷ 120°C

MATERIALI

- Girante in ghisa (o bronzo)
- Corpo pompa in ghisa
- Albero in acciaio inox AISI 420
- Tenuta meccanica in SiC/Carbone/EPDM

SIGLA IDENTIFICATIVA

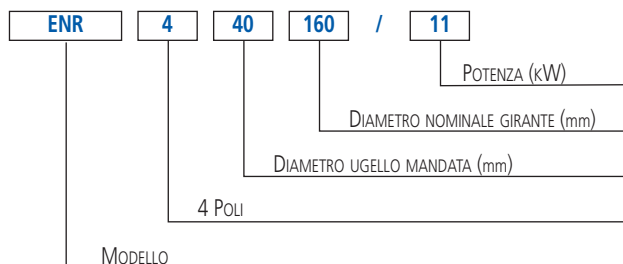

ELETTROPOMPE CENTRIFUGHE MONOBLOCCO SECONDO EN 733

in ghisa

CURVE DI PRESTAZIONE serie ENR

(secondo ISO 9906 Allegato A)

2 Poli

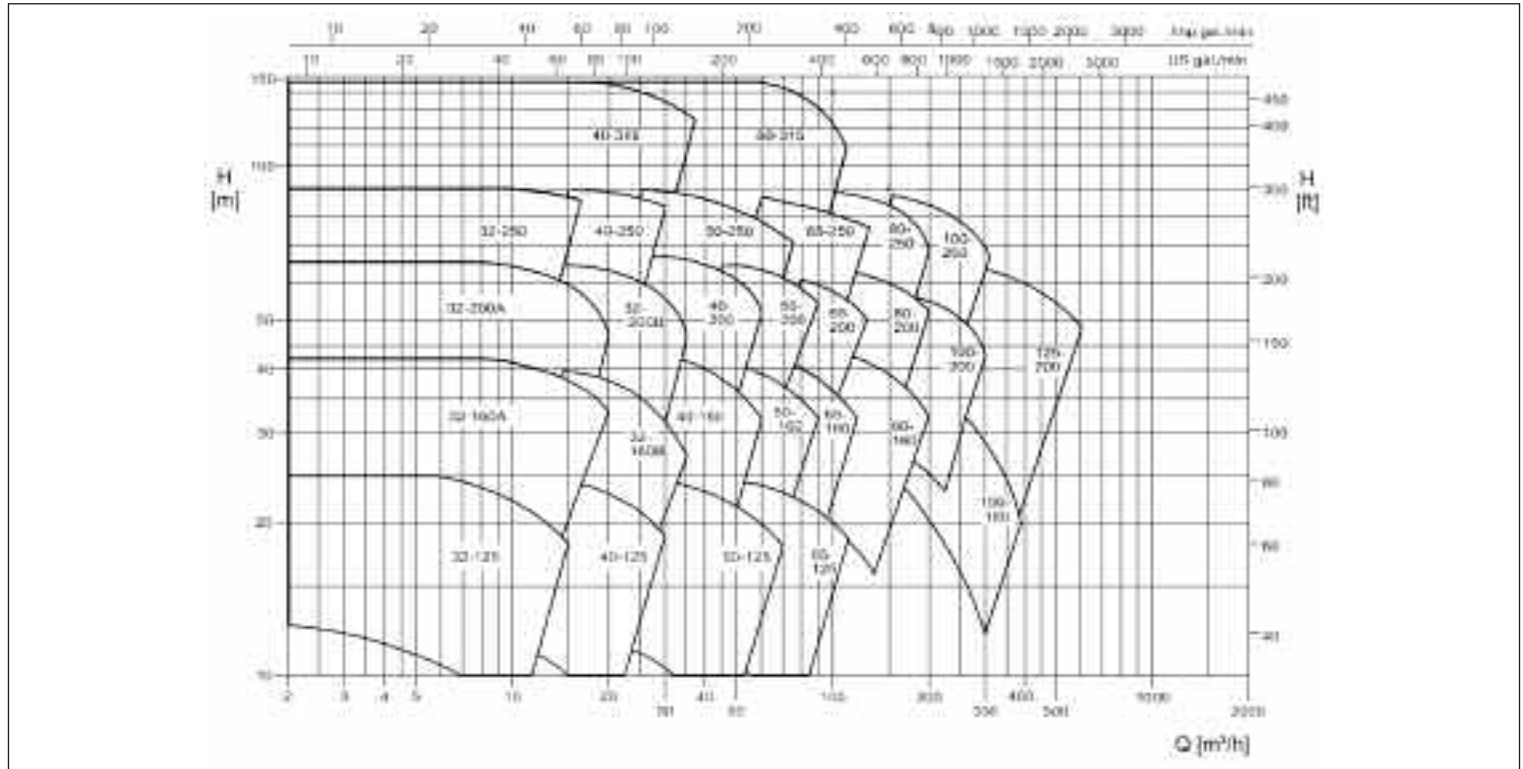

CURVE DI PRESTAZIONE serie ENR

(secondo ISO 9906 Allegato A)

4 Poli

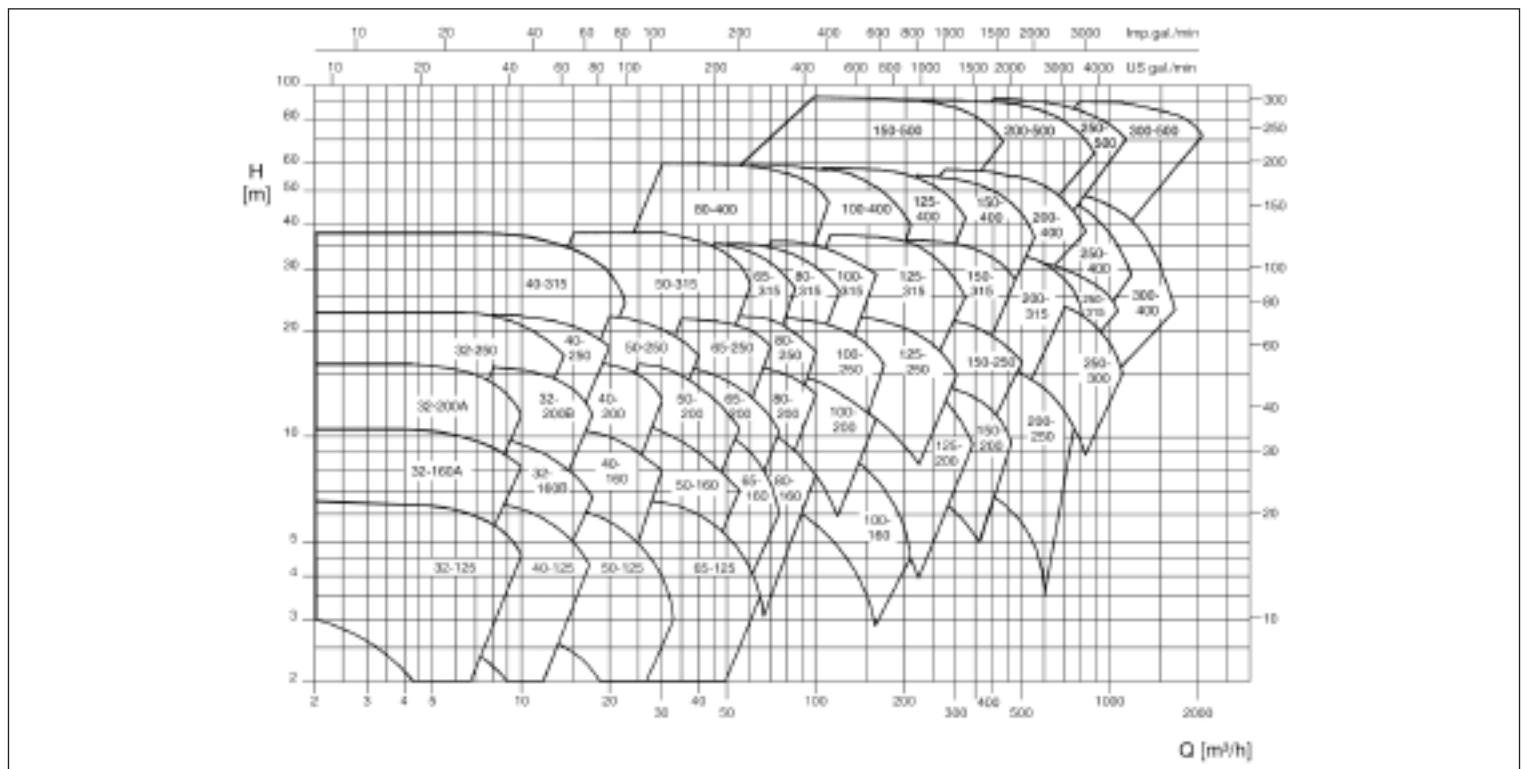

ELETTROPOMPE CENTRIFUGHE MONOBLOCCO SECONDO EN 733

in ghisa

CURVE DI PRESTAZIONE serie ENR 32-125

(secondo ISO 9906 Allegato A)

2 Poli

CURVE DI PRESTAZIONE serie ENR 32-160A

(secondo ISO 9906 Allegato A)

2 Poli

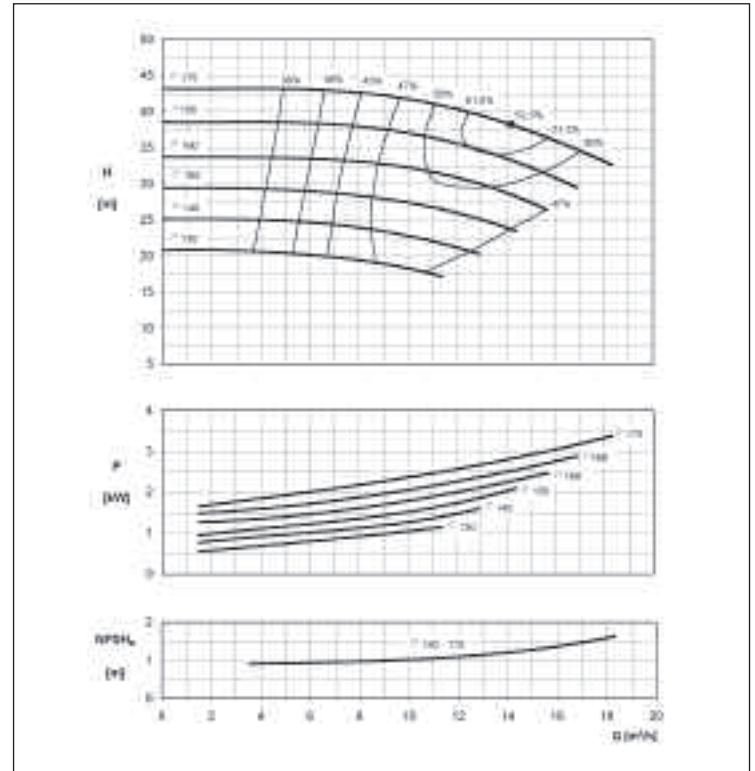
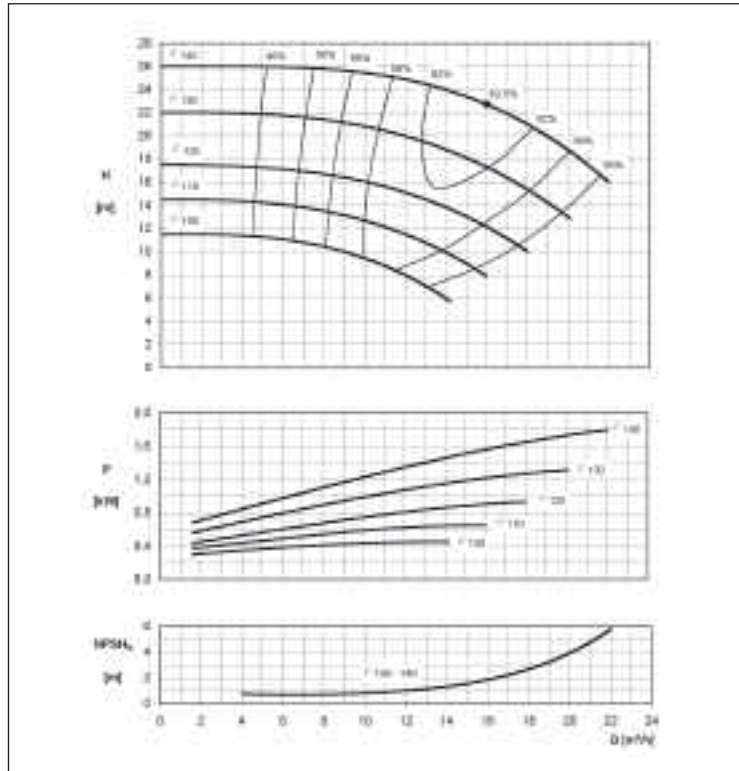

CURVE DI PRESTAZIONE serie ENR 32-160B

(secondo ISO 9906 Allegato A)

2 Poli

CURVE DI PRESTAZIONE serie ENR 32-200A

(secondo ISO 9906 Allegato A)

2 Poli

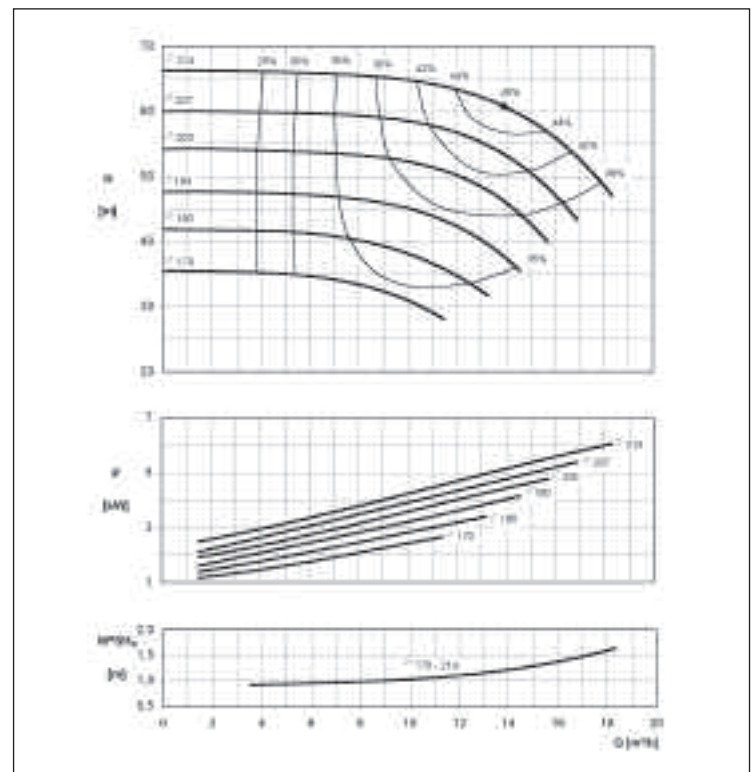
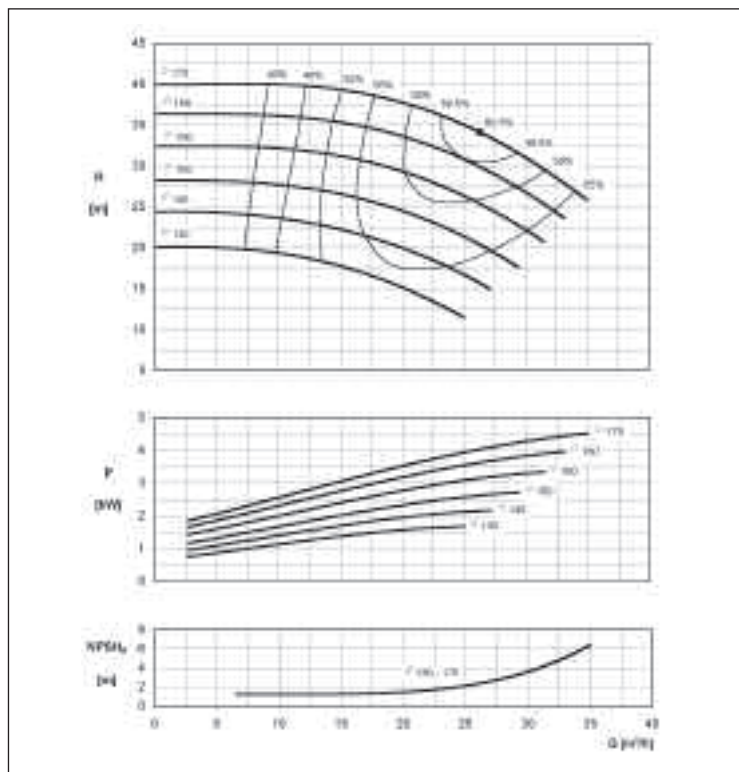

ELETTROPOMPE CENTRIFUGHE MONOBLOCCO SECONDO EN 733 in ghisa

CURVE DI PRESTAZIONE serie ENR 32-200B
(secondo ISO 9906 Allegato A)

2 Poli

CURVE DI PRESTAZIONE serie ENR 32-250
(secondo ISO 9906 Allegato A)

2 Poli

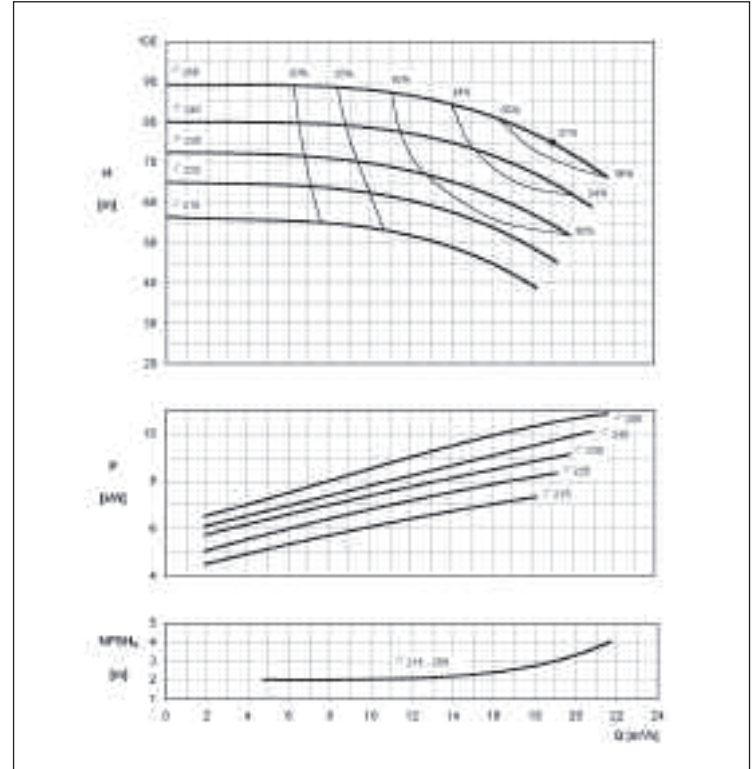
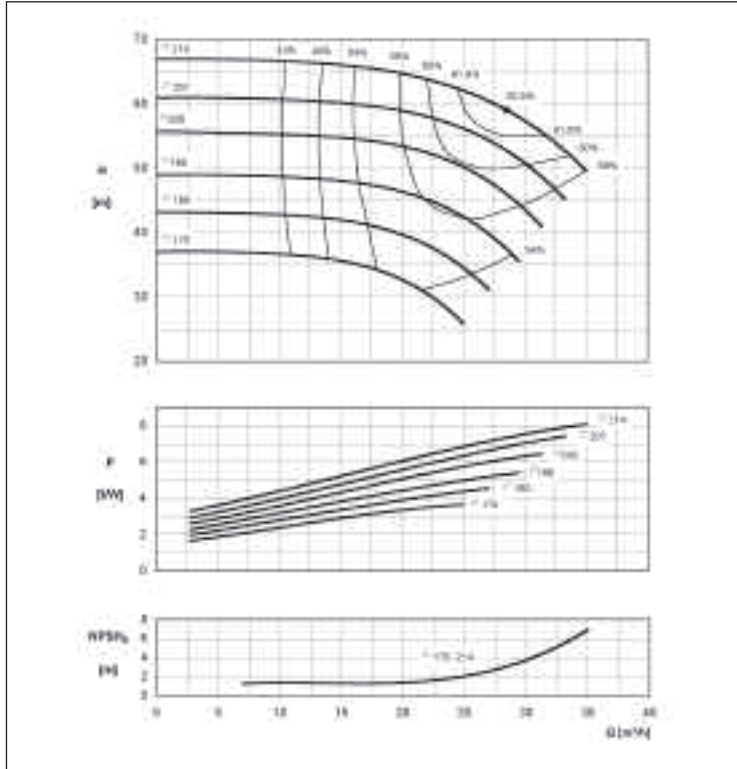

CURVE DI PRESTAZIONE serie ENR 40-125
(secondo ISO 9906 Allegato A)

2 Poli

CURVE DI PRESTAZIONE serie ENR 40-160
(secondo ISO 9906 Allegato A)

2 Poli

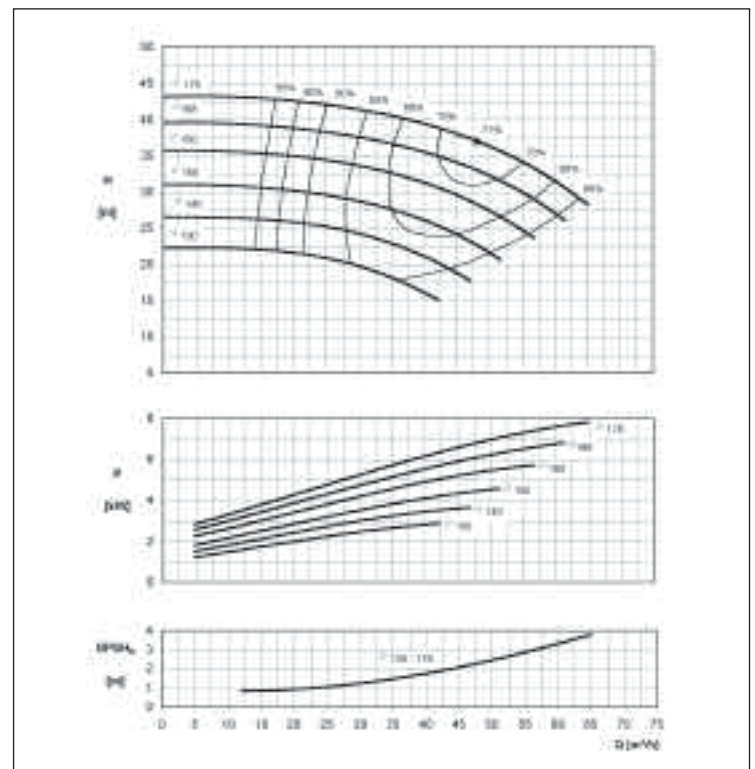
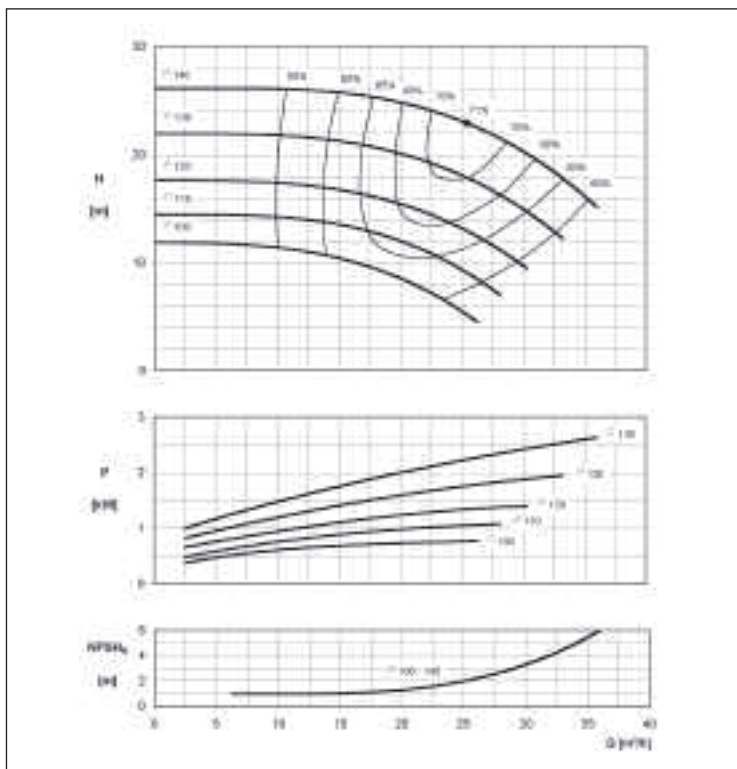

ELETTROPOMPE CENTRIFUGHE MONOBLOCCO SECONDO EN 733

in ghisa

CURVE DI PRESTAZIONE serie ENR 40-200

(secondo ISO 9906 Allegato A)

2 Poli

CURVE DI PRESTAZIONE serie ENR 40-250

(secondo ISO 9906 Allegato A)

2 Poli

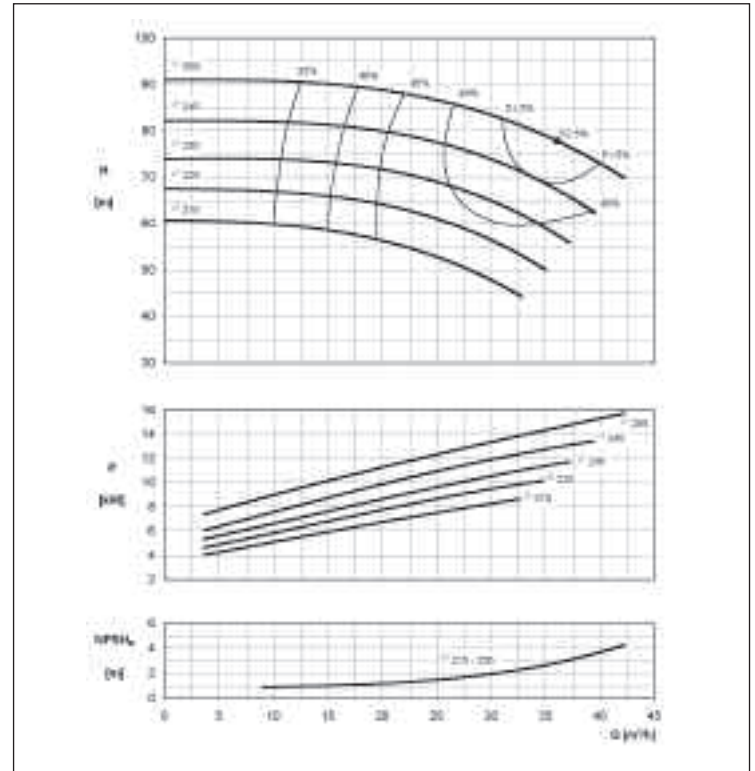
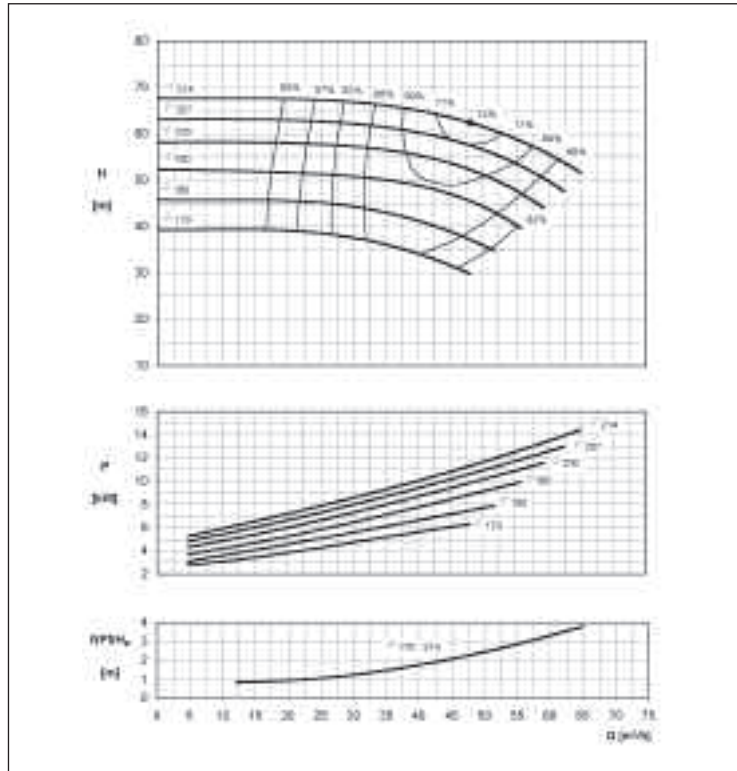

CURVE DI PRESTAZIONE serie ENR 40-315

(secondo ISO 9906 Allegato A)

2 Poli

CURVE DI PRESTAZIONE serie ENR 50-125

(secondo ISO 9906 Allegato A)

2 Poli

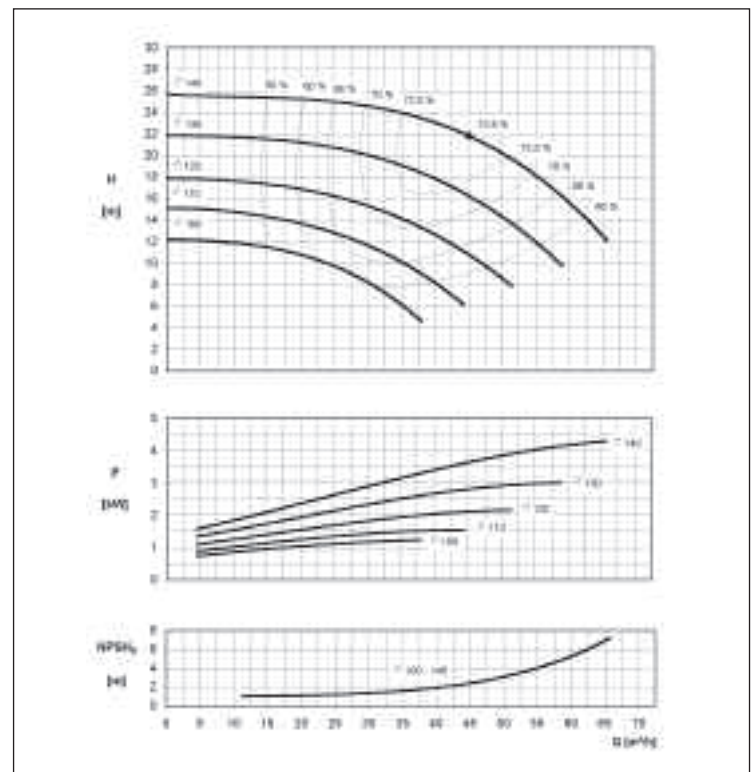
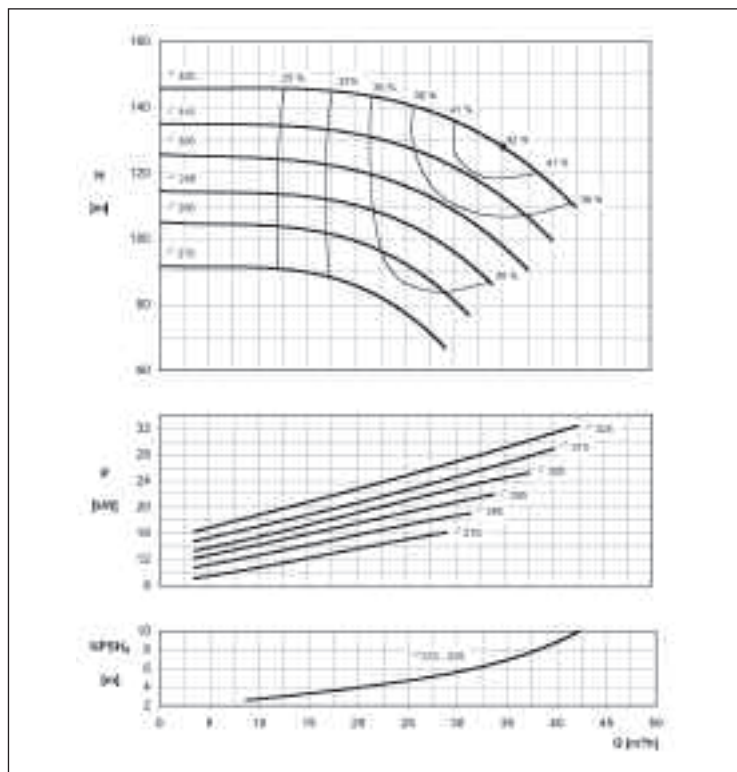

ELETTROPOMPE CENTRIFUGHE MONOBLOCCO SECONDO EN 733 in ghisa

CURVE DI PRESTAZIONE serie ENR 50-160
(secondo ISO 9906 Allegato A)

2 Poli

CURVE DI PRESTAZIONE serie ENR 50-200
(secondo ISO 9906 Allegato A)

2 Poli

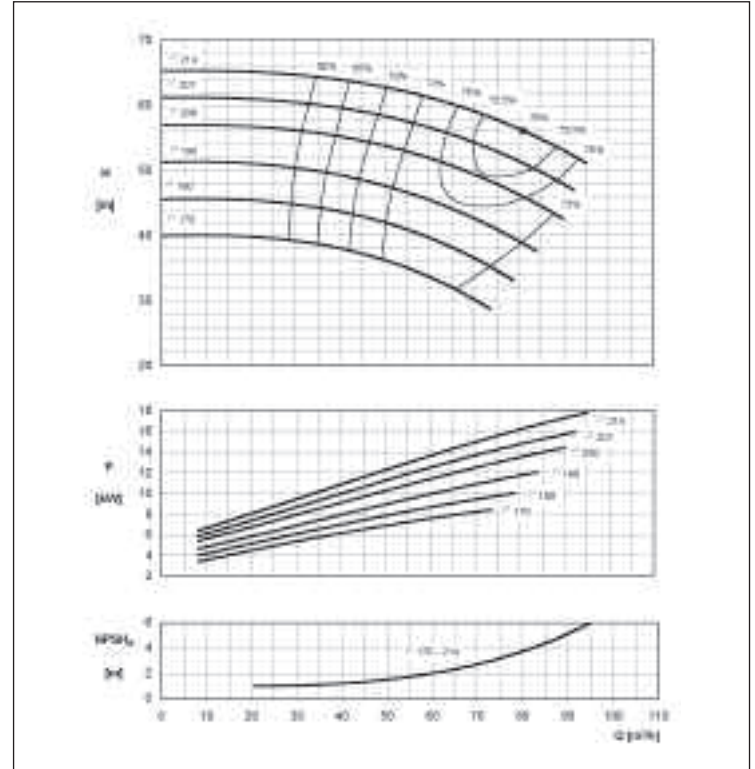
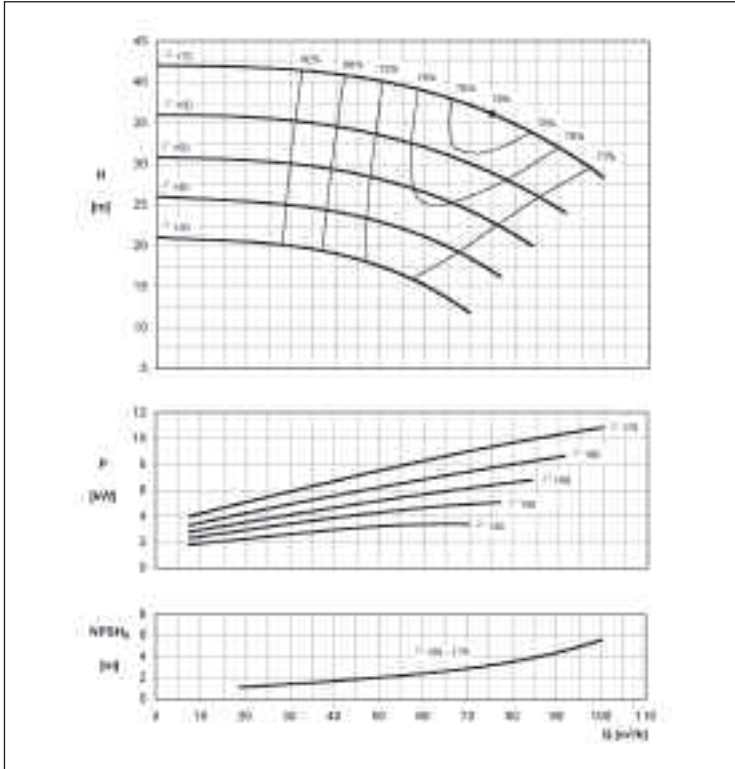

CURVE DI PRESTAZIONE serie ENR 50-250
(secondo ISO 9906 Allegato A)

2 Poli

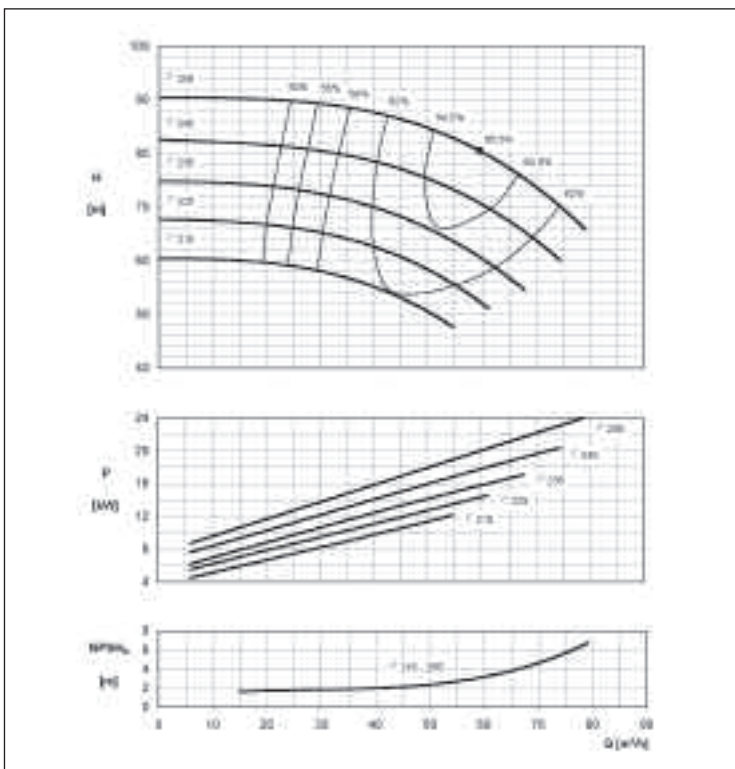

ELETTROPOMPE CENTRIFUGHE MONOBLOCCO SECONDO EN 733

in ghisa

CURVE DI PRESTAZIONE serie ENR 50-315

(secondo ISO 9906 Allegato A)

2 Poli

CURVE DI PRESTAZIONE serie ENR 65-125

(secondo ISO 9906 Allegato A)

2 Poli

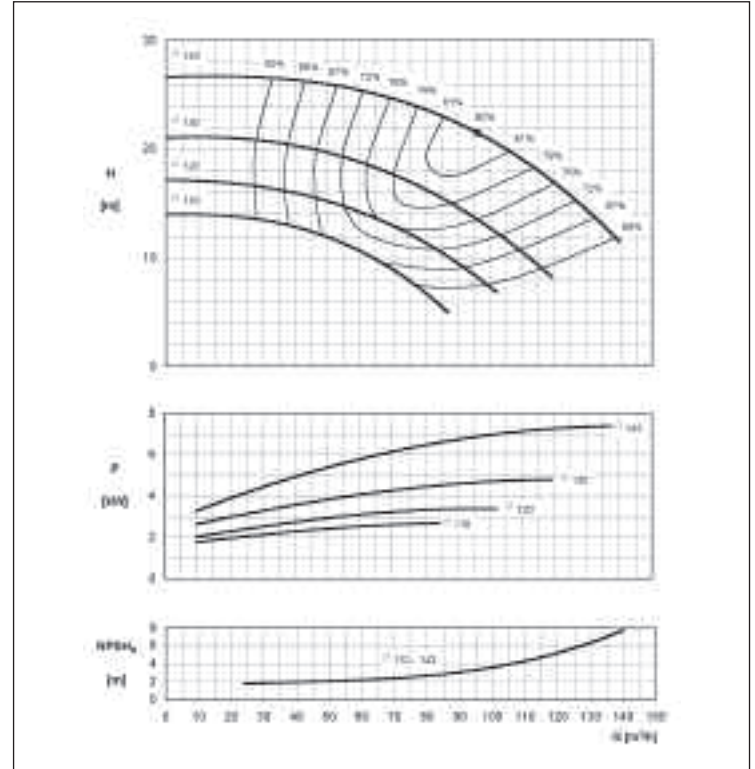
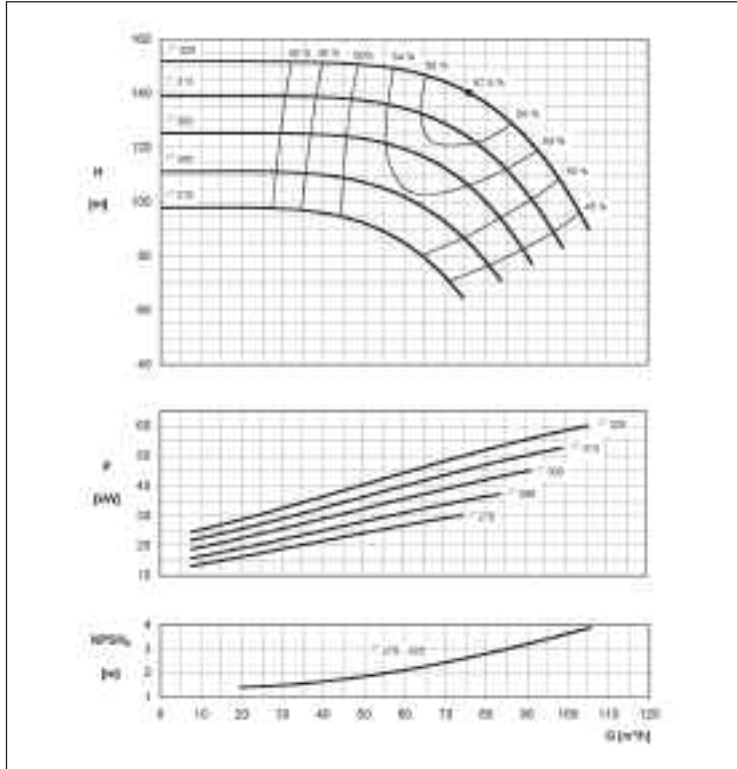

CURVE DI PRESTAZIONE serie ENR 65-160

(secondo ISO 9906 Allegato A)

2 Poli

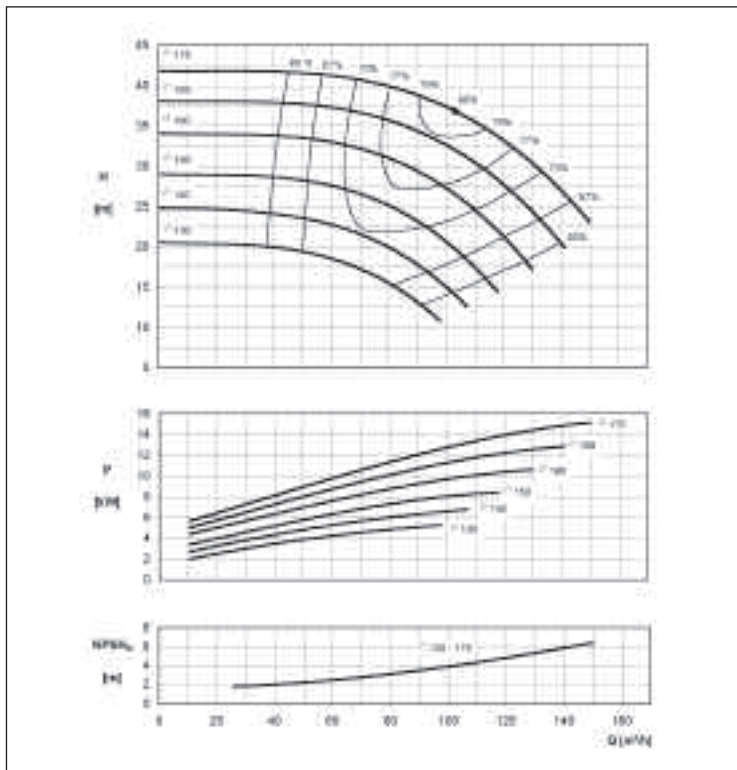

ELETTROPOMPE CENTRIFUGHE MONOBLOCCO SECONDO EN 733 in ghisa

CURVE DI PRESTAZIONE serie ENR 65-200
(secondo ISO 9906 Allegato A)

2 Poli

CURVE DI PRESTAZIONE serie ENR 65-250
(secondo ISO 9906 Allegato A)

2 Poli

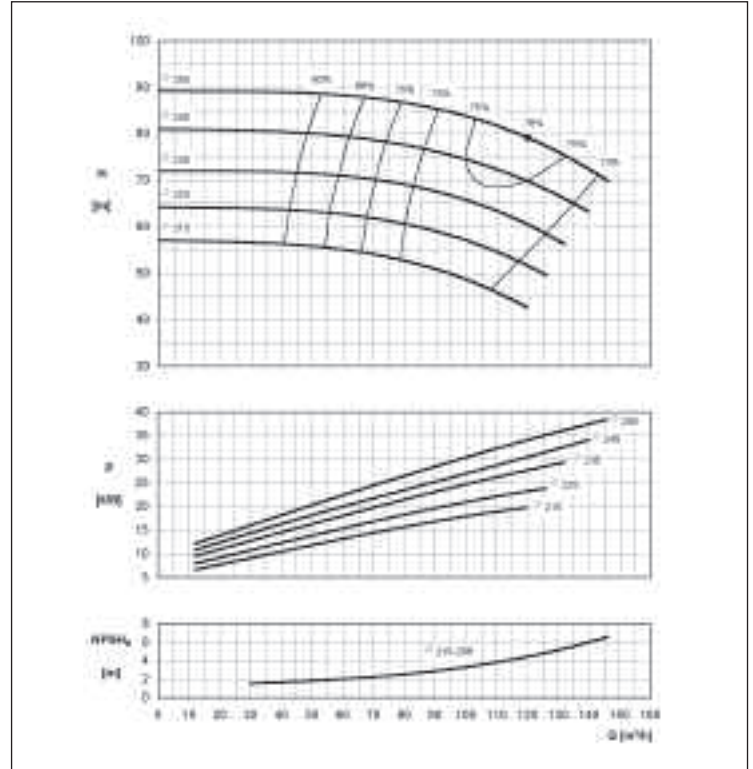
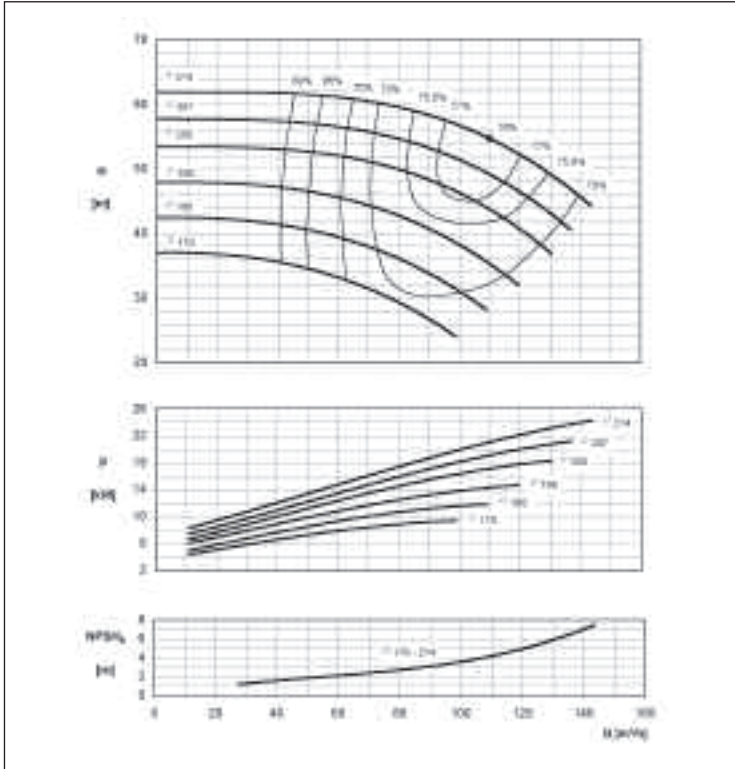

CURVE DI PRESTAZIONE serie ENR 80-160
(secondo ISO 9906 Allegato A)

2 Poli

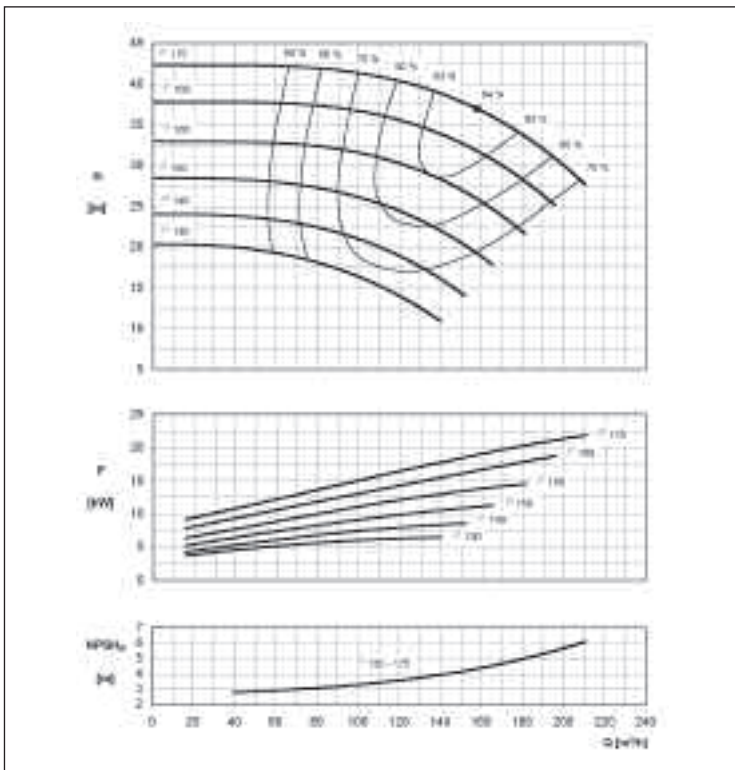

ELETTROPOMPE CENTRIFUGHE MONOBLOCCO SECONDO EN 733

in ghisa

CURVE DI PRESTAZIONE serie ENR 100-200

(secondo ISO 9906 Allegato A)

2 Poli

CURVE DI PRESTAZIONE serie ENR 100-250

(secondo ISO 9906 Allegato A)

2 Poli

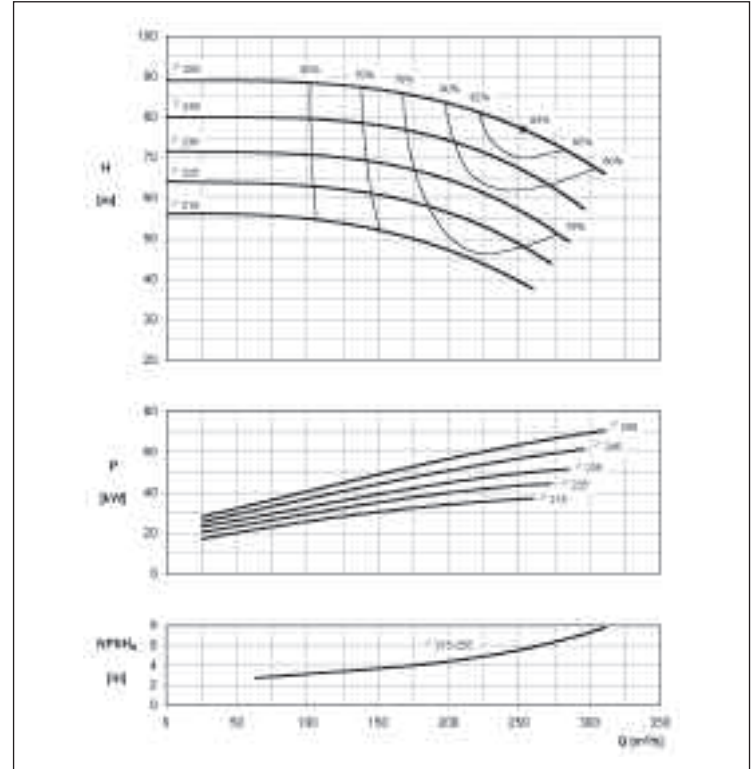
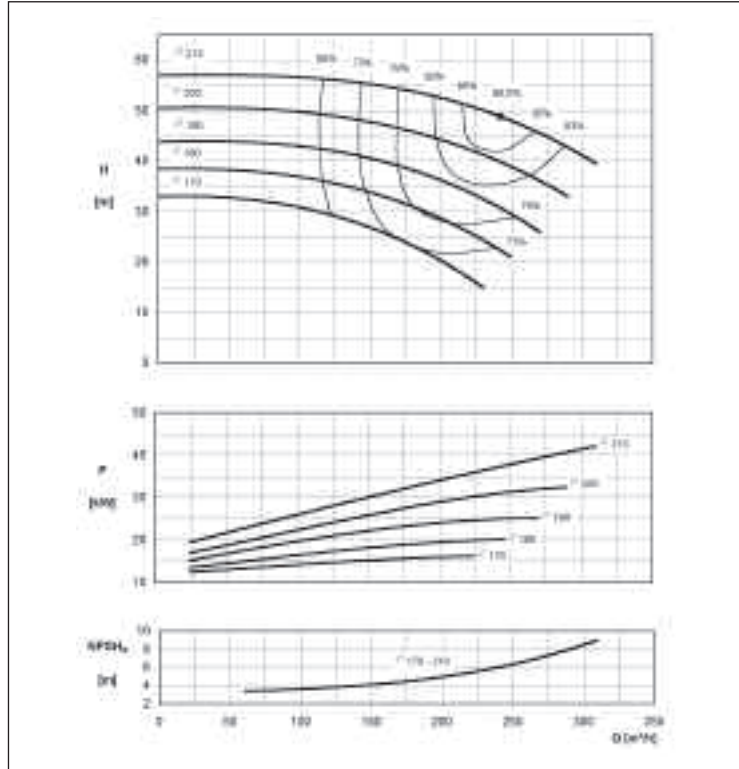

CURVE DI PRESTAZIONE serie ENR 125-200

(secondo ISO 9906 Allegato A)

2 Poli

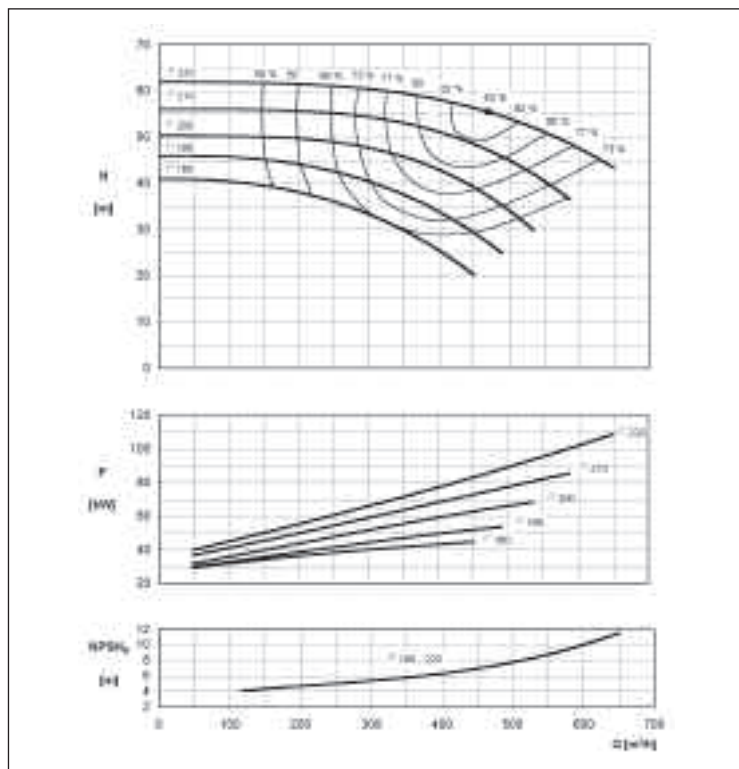

ELETTROPOMPE CENTRIFUGHE MONOBLOCCO SECONDO EN 733

in ghisa

CURVE DI PRESTAZIONE serie ENR 32-125

(secondo ISO 9906 Allegato A)

4 Poli

CURVE DI PRESTAZIONE serie ENR 32-160A

(secondo ISO 9906 Allegato A)

4 Poli

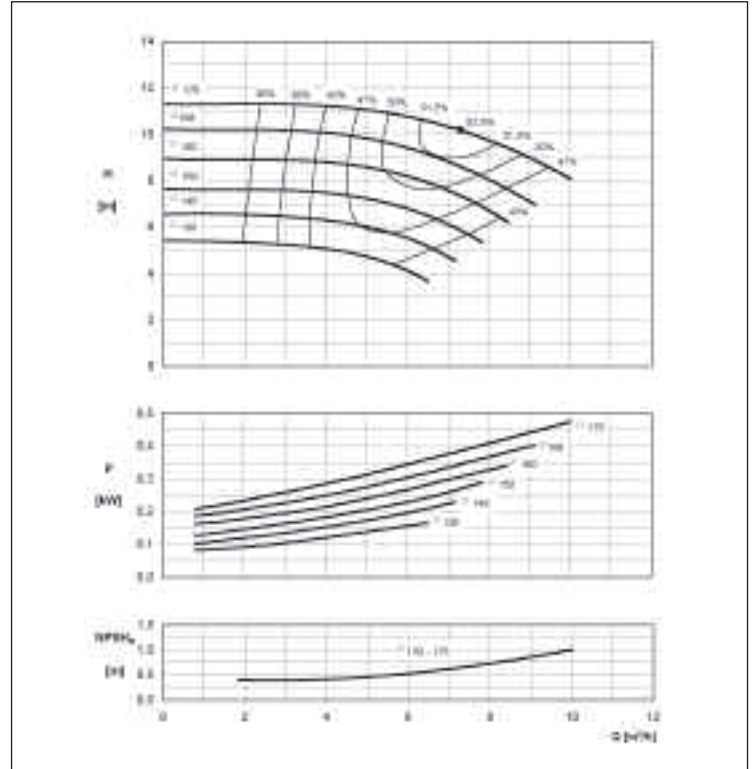
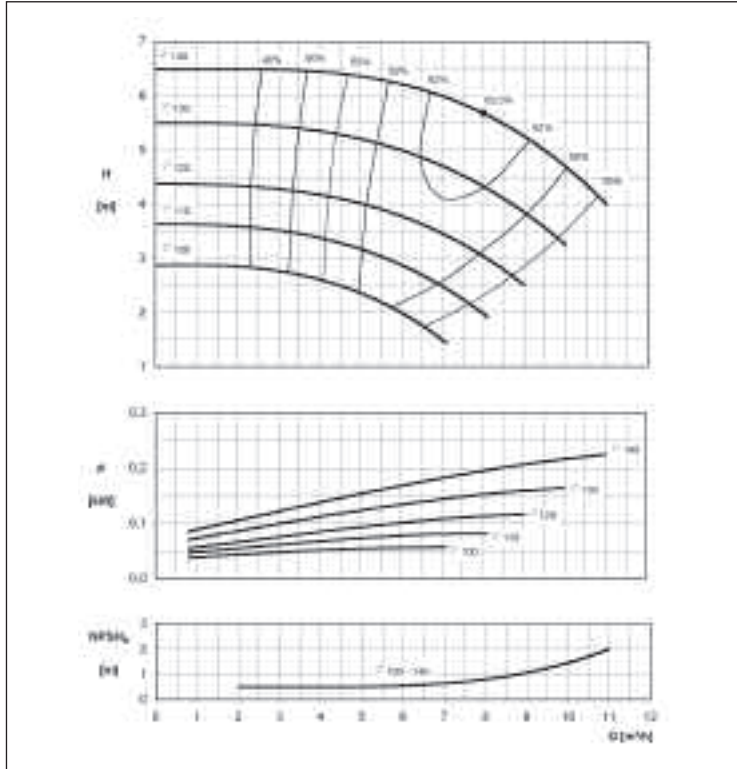

CURVE DI PRESTAZIONE serie ENR 32-160B

(secondo ISO 9906 Allegato A)

4 Poli

CURVE DI PRESTAZIONE serie ENR 32-200A

(secondo ISO 9906 Allegato A)

4 Poli

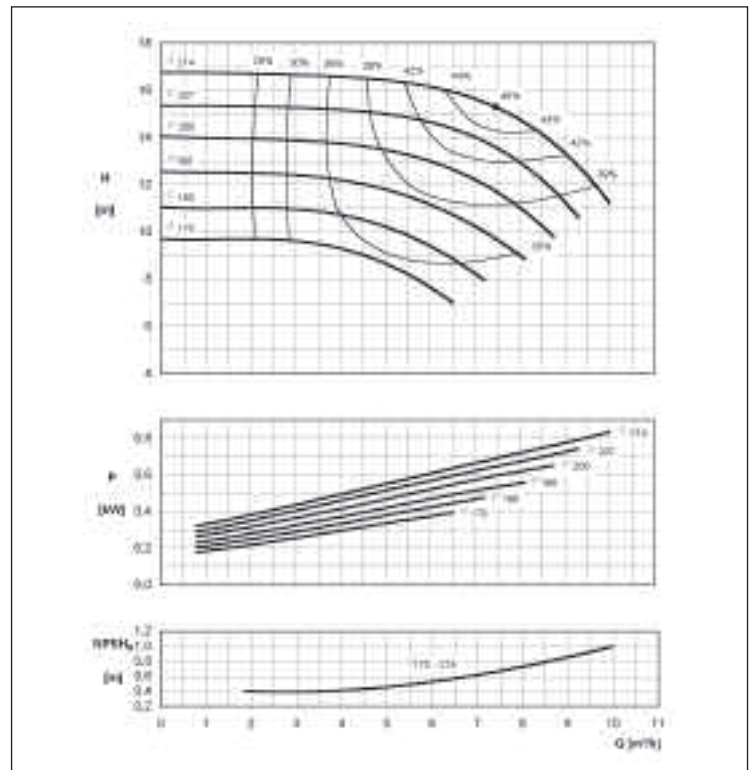
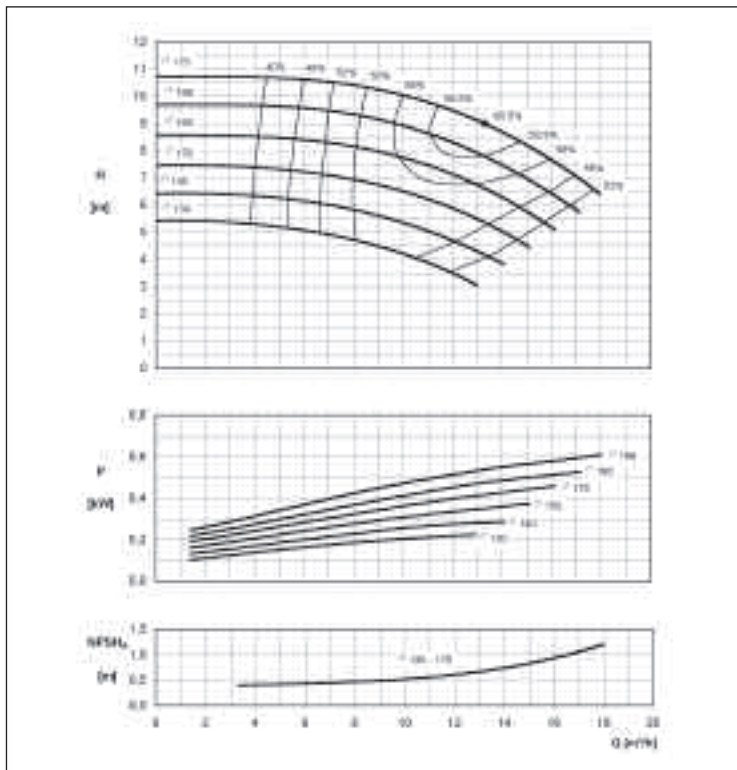

ELETTROPOMPE CENTRIFUGHE MONOBLOCCO SECONDO EN 733 in ghisa

CURVE DI PRESTAZIONE serie ENR 32-200B
(secondo ISO 9906 Allegato A)

4 Poli

CURVE DI PRESTAZIONE serie ENR 32-250
(secondo ISO 9906 Allegato A)

4 Poli

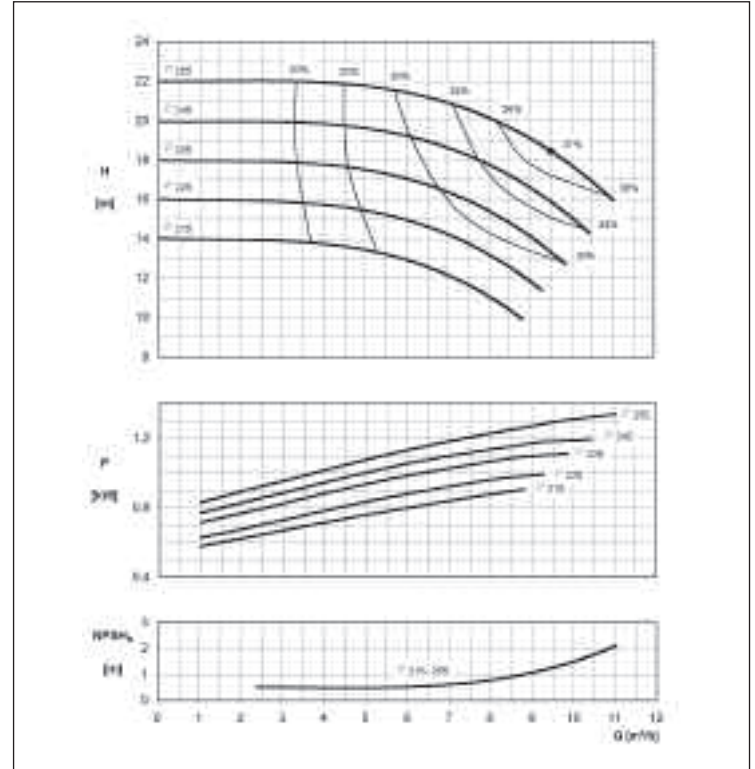
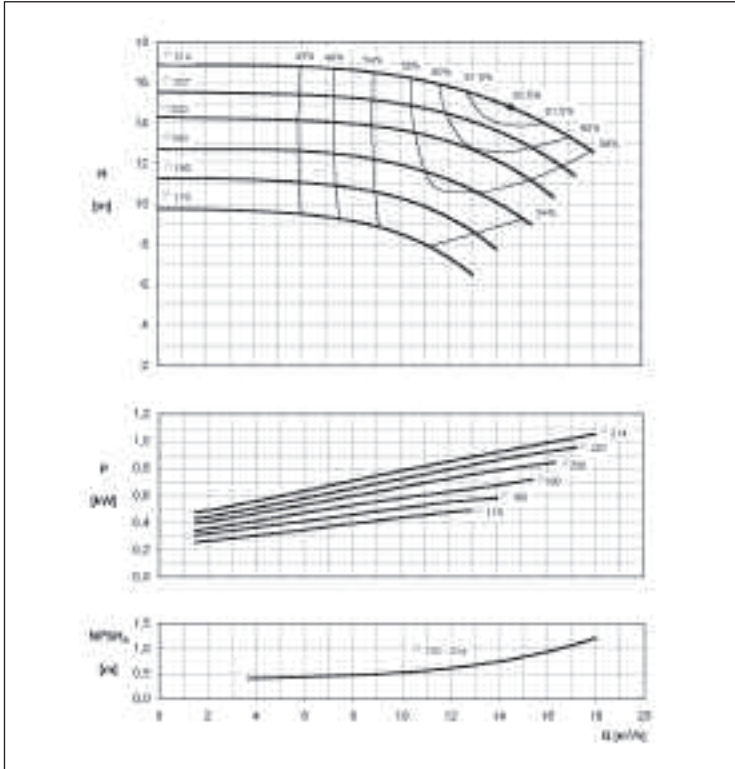

CURVE DI PRESTAZIONE serie ENR 40-125
(secondo ISO 9906 Allegato A)

4 Poli

CURVE DI PRESTAZIONE serie ENR 40-160
(secondo ISO 9906 Allegato A)

4 Poli

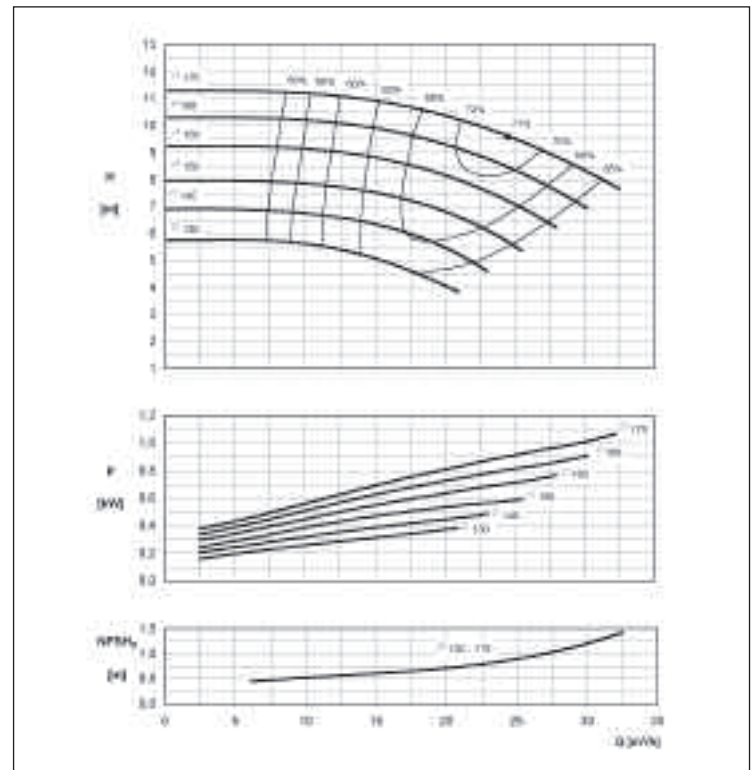
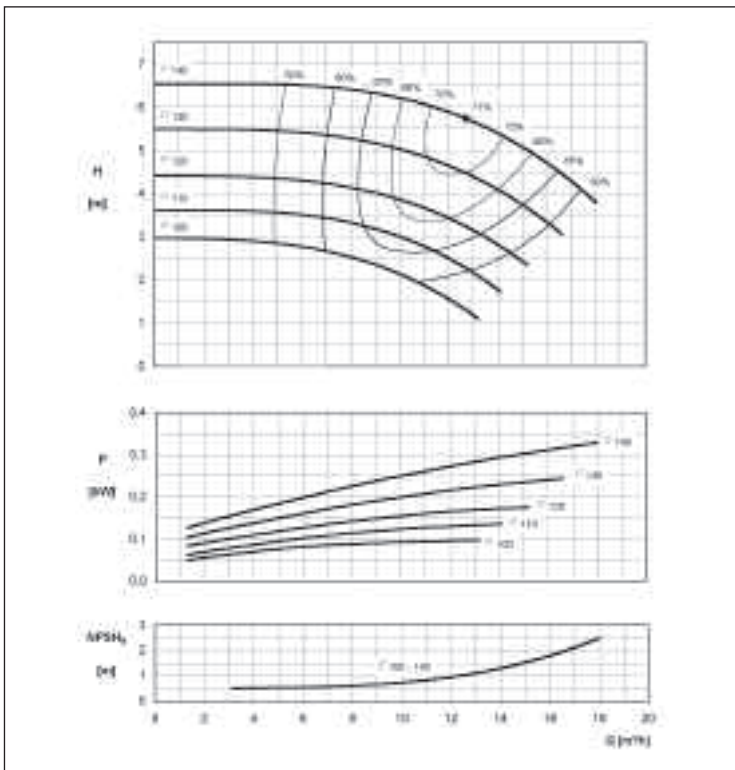

ELETTROPOMPE CENTRIFUGHE MONOBLOCCO SECONDO EN 733

in ghisa

CURVE DI PRESTAZIONE serie ENR 40-200

(secondo ISO 9906 Allegato A)

4 Poli

CURVE DI PRESTAZIONE serie ENR 40-250

(secondo ISO 9906 Allegato A)

4 Poli

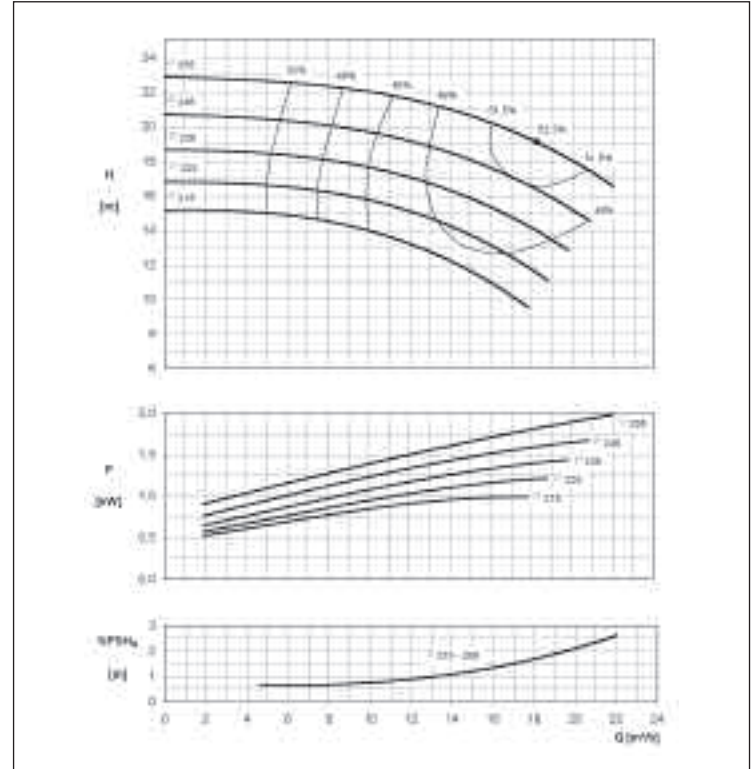
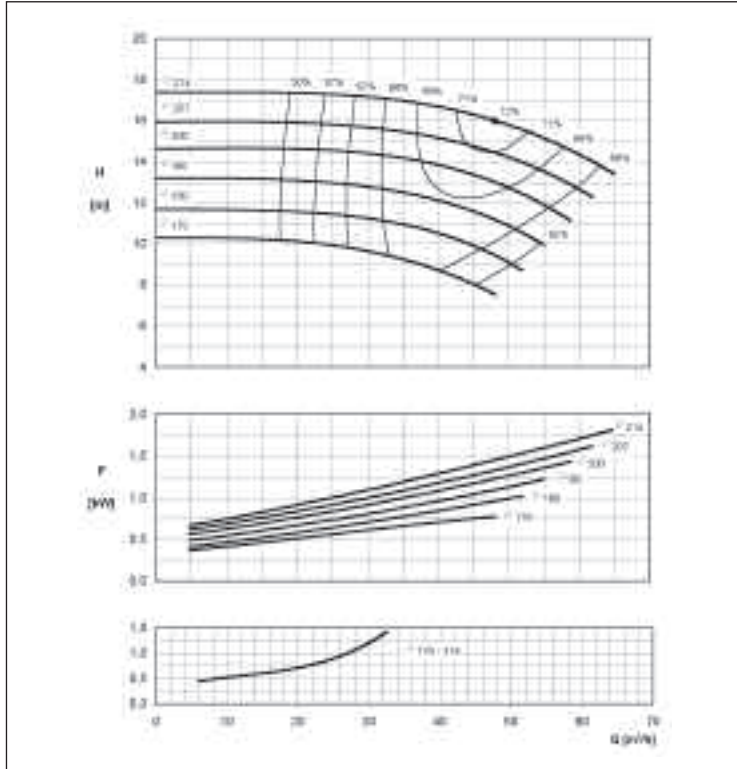

CURVE DI PRESTAZIONE serie ENR 40-315

(secondo ISO 9906 Allegato A)

4 Poli

CURVE DI PRESTAZIONE serie ENR 50-125

(secondo ISO 9906 Allegato A)

4 Poli

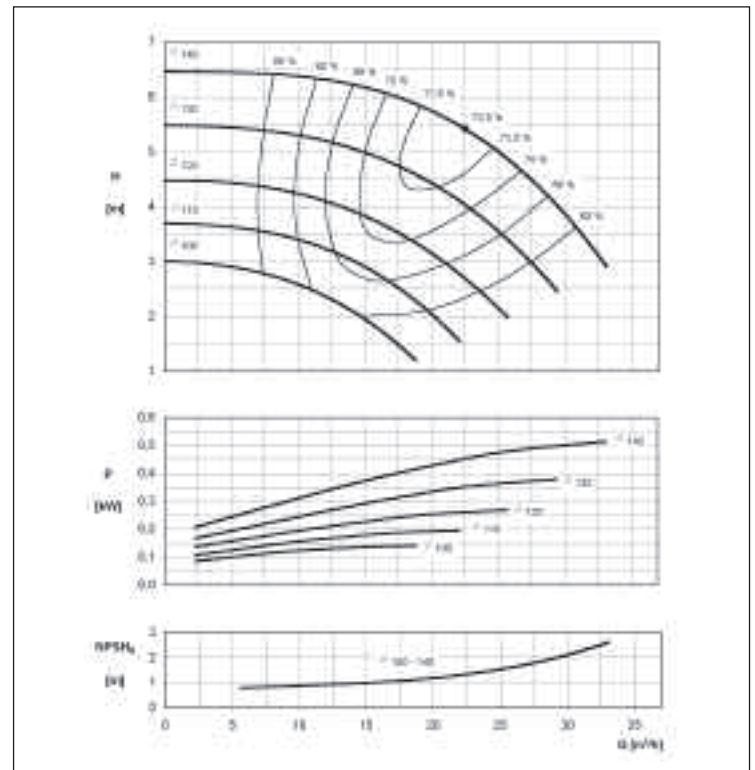
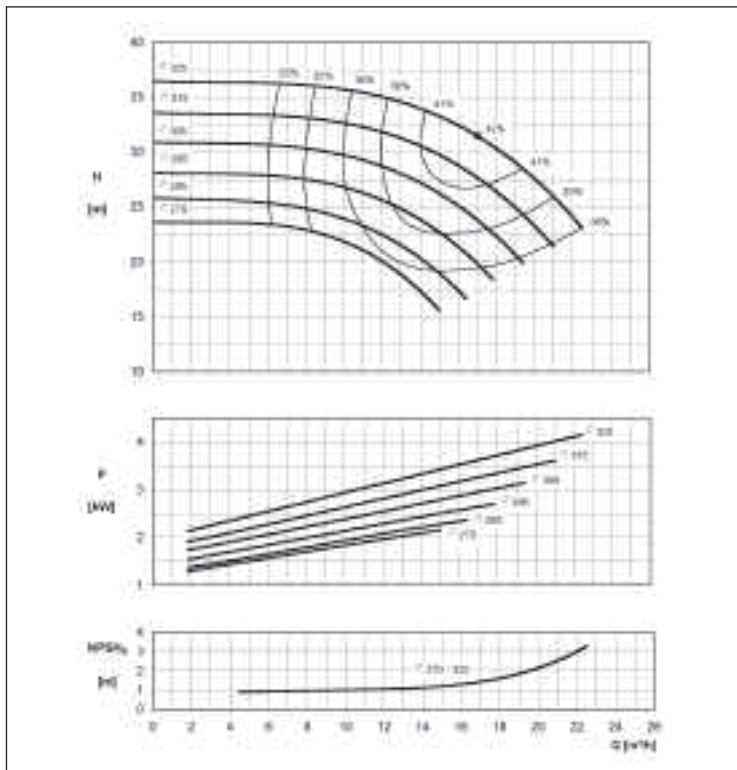

ELETTROPOMPE CENTRIFUGHE MONOBLOCCO SECONDO EN 733

in ghisa

CURVE DI PRESTAZIONE serie ENR 50-160

(secondo ISO 9906 Allegato A)

4 Poli

CURVE DI PRESTAZIONE serie ENR 50-200

(secondo ISO 9906 Allegato A)

4 Poli

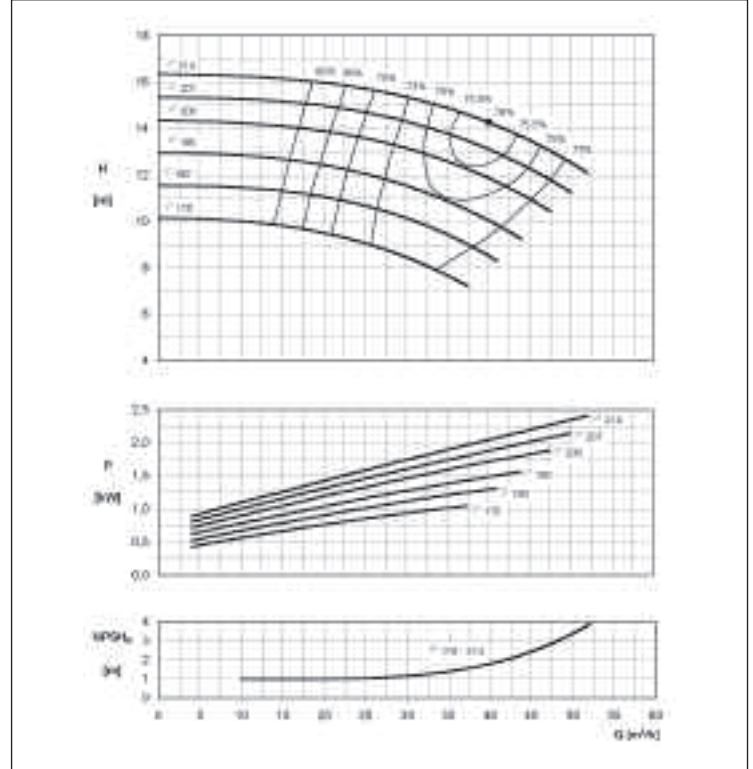
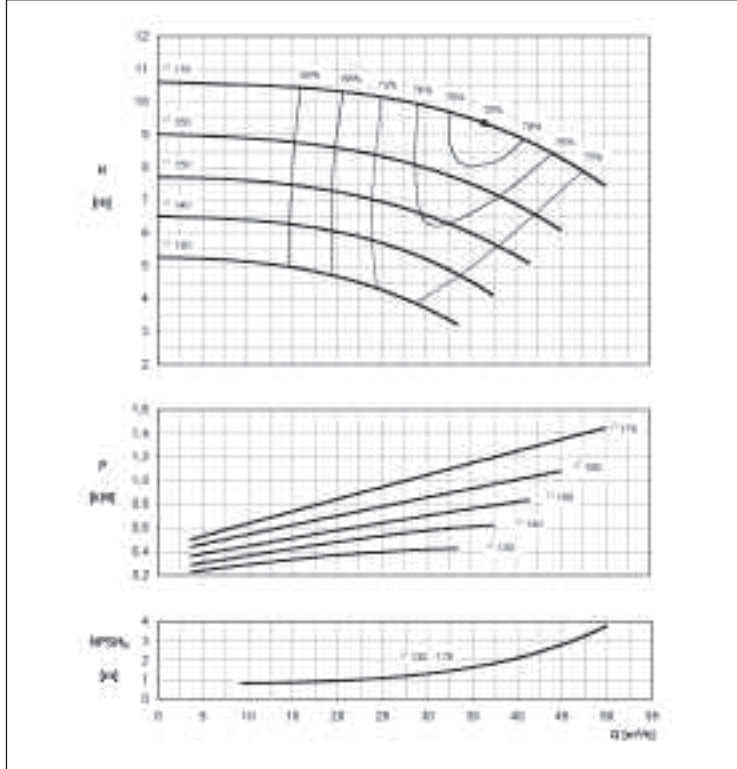

CURVE DI PRESTAZIONE serie ENR 50-250

(secondo ISO 9906 Allegato A)

4 Poli

CURVE DI PRESTAZIONE serie ENR 50-315

(secondo ISO 9906 Allegato A)

4 Poli

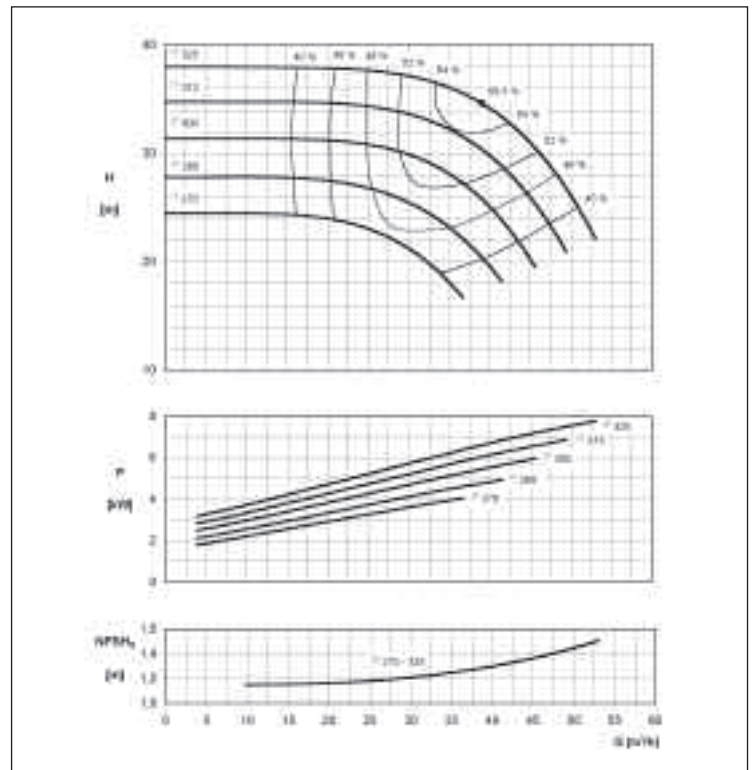
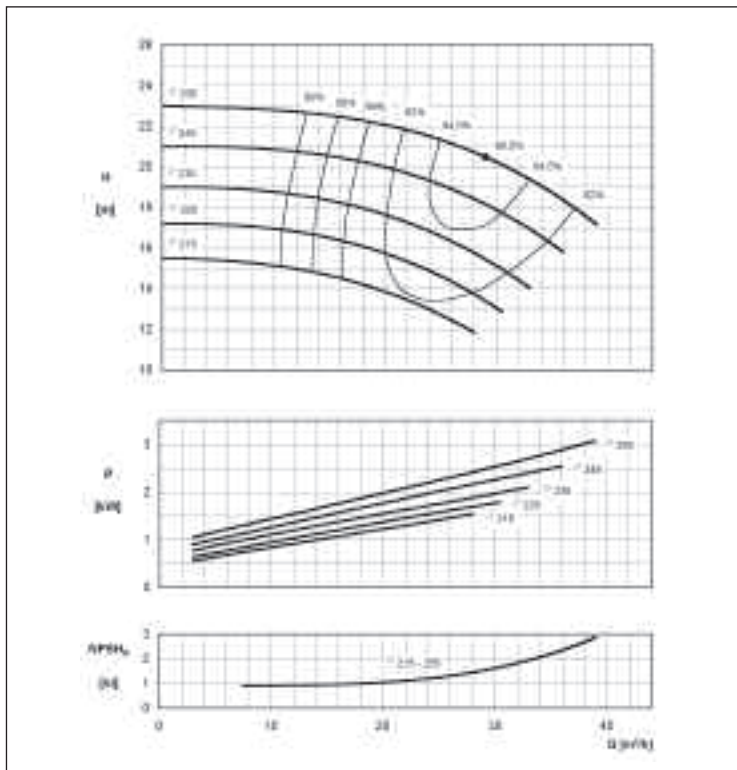

ELETTROPOMPE CENTRIFUGHE MONOBLOCCO SECONDO EN 733

in ghisa

CURVE DI PRESTAZIONE serie ENR 65-125

(secondo ISO 9906 Allegato A)

4 Poli

CURVE DI PRESTAZIONE serie ENR 65-160

(secondo ISO 9906 Allegato A)

4 Poli

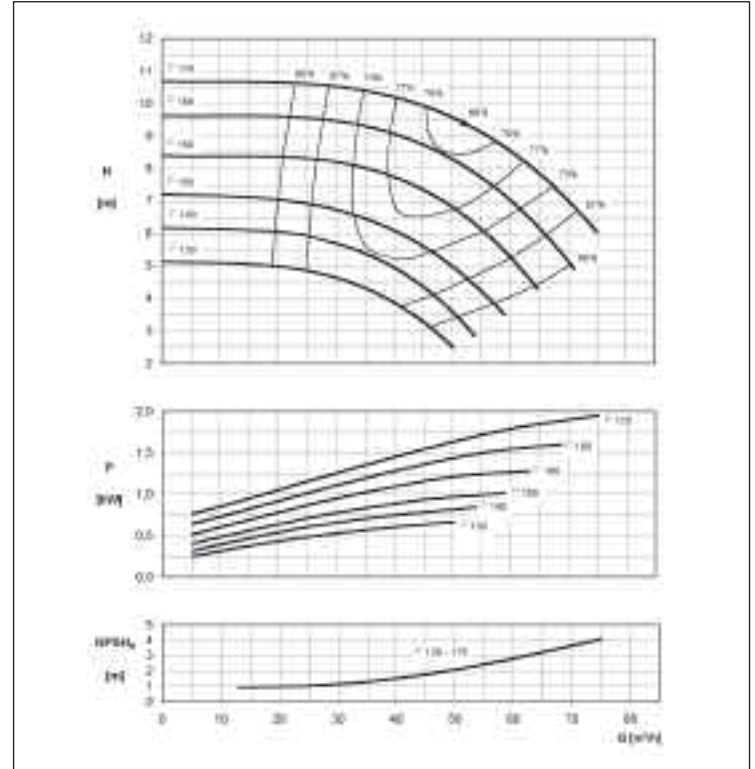
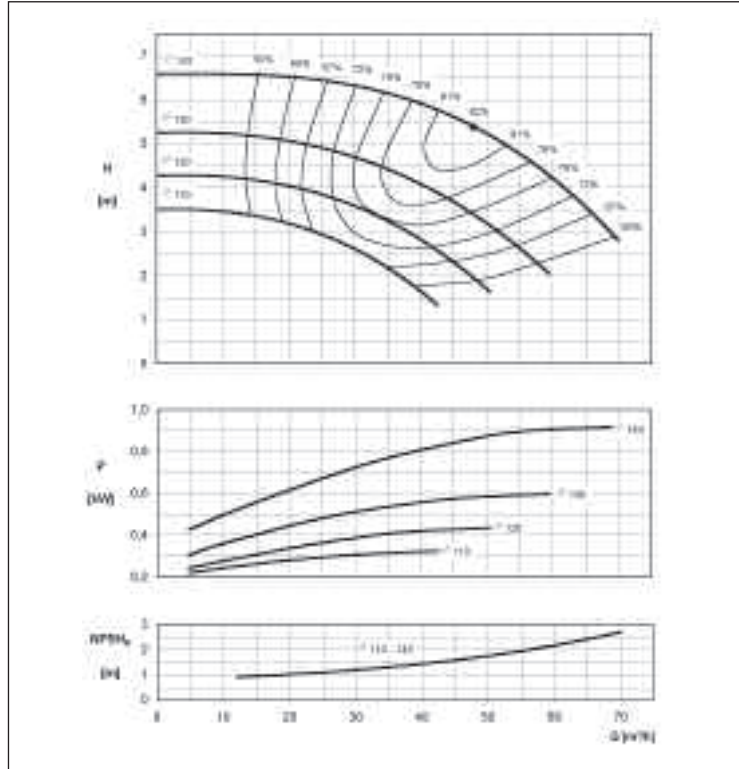

CURVE DI PRESTAZIONE serie ENR 65-200

(secondo ISO 9906 Allegato A)

4 Poli

CURVE DI PRESTAZIONE serie ENR 65-250

(secondo ISO 9906 Allegato A)

4 Poli

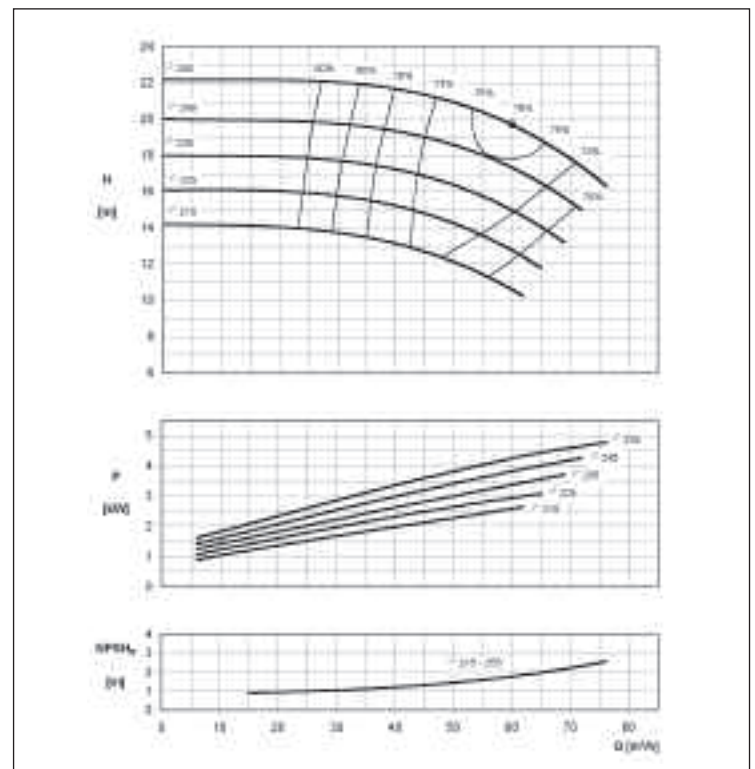
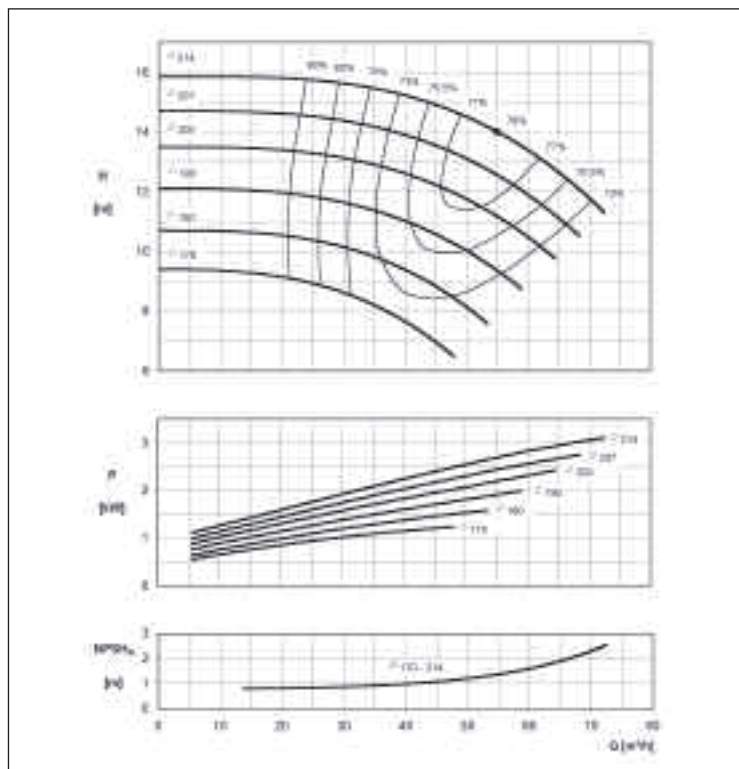

ELETTROPOMPE CENTRIFUGHE MONOBLOCCO SECONDO EN 733 in ghisa

CURVE DI PRESTAZIONE serie ENR 65-315
(secondo ISO 9906 Allegato A)

4 Poli

CURVE DI PRESTAZIONE serie ENR 80-160
(secondo ISO 9906 Allegato A)

4 Poli

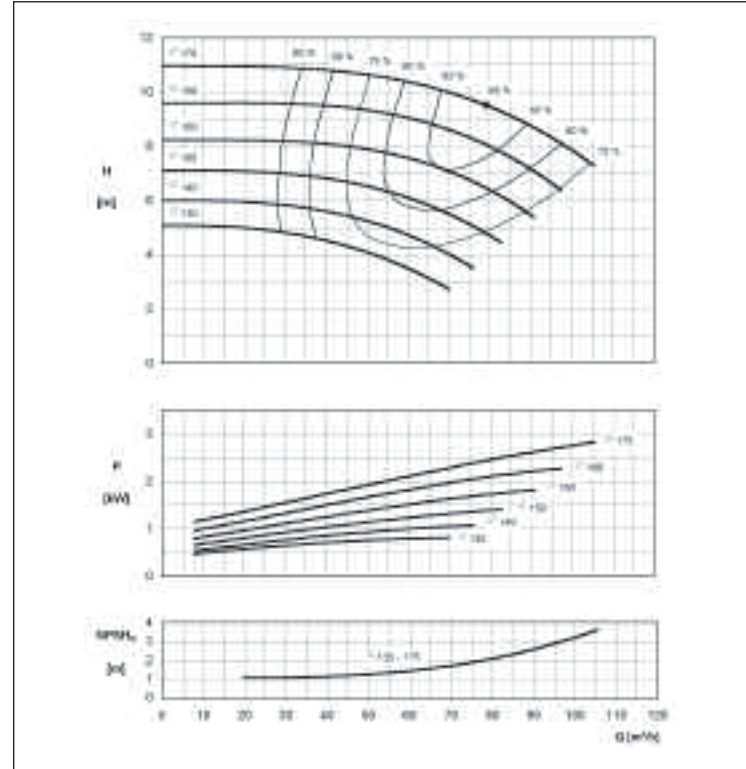
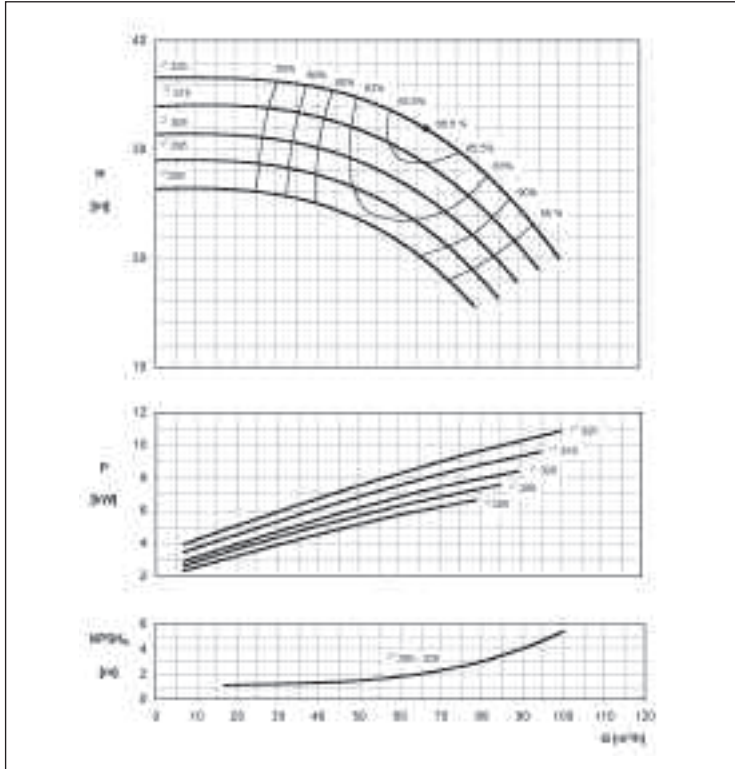

CURVE DI PRESTAZIONE serie ENR 80-200
(secondo ISO 9906 Allegato A)

4 Poli

CURVE DI PRESTAZIONE serie ENR 80-250
(secondo ISO 9906 Allegato A)

4 Poli

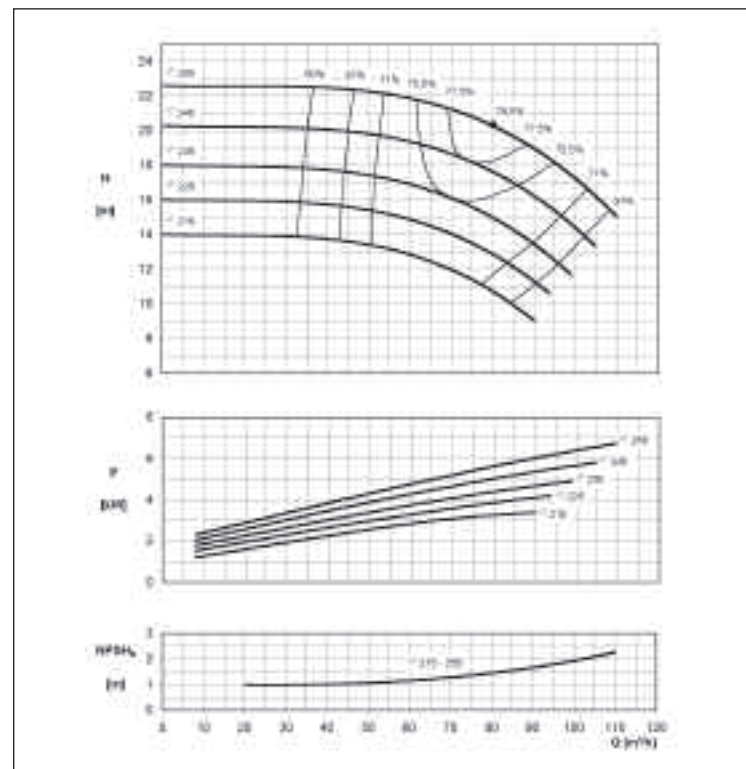
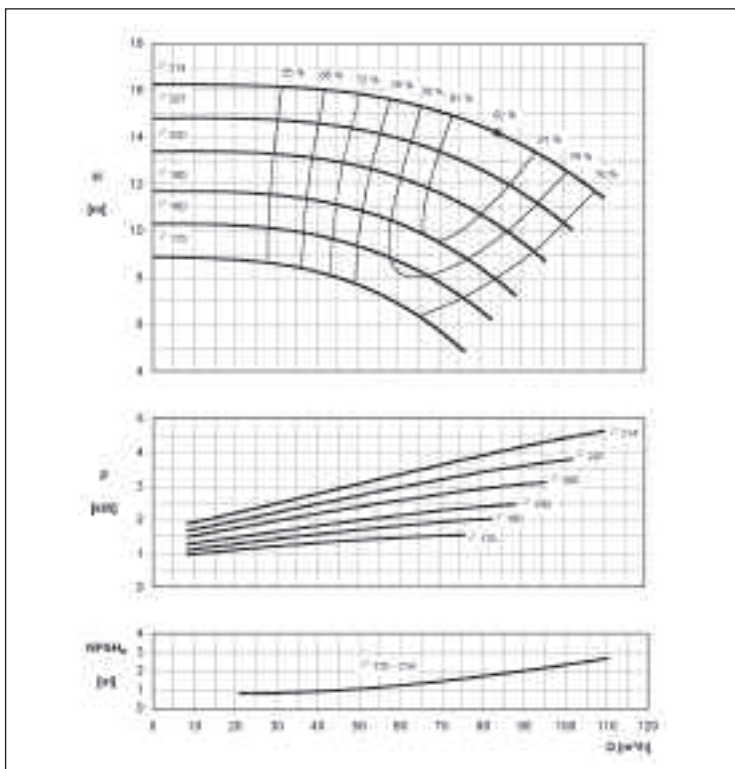

ELETTROPOMPE CENTRIFUGHE MONOBLOCCO SECONDO EN 733

in ghisa

CURVE DI PRESTAZIONE serie ENR 80-315

(secondo ISO 9906 Allegato A)

4 Poli

CURVE DI PRESTAZIONE serie ENR 80-400

(secondo ISO 9906 Allegato A)

4 Poli

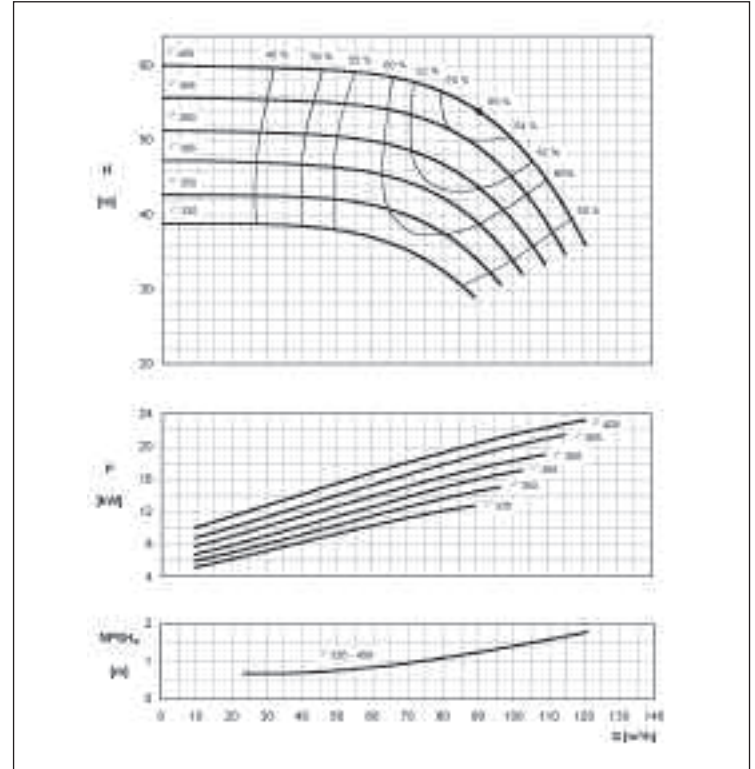
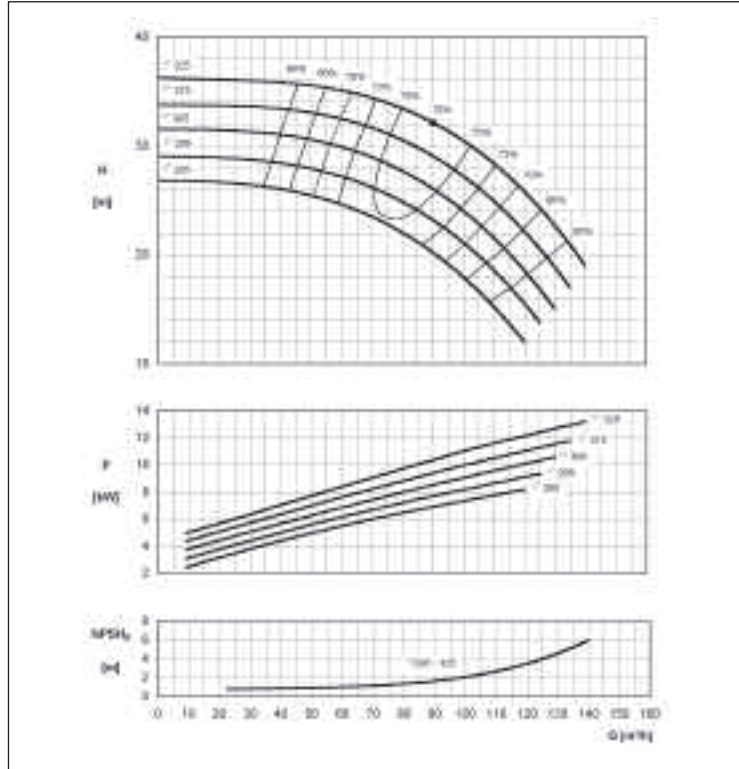

CURVE DI PRESTAZIONE serie ENR 100-160

(secondo ISO 9906 Allegato A)

4 Poli

CURVE DI PRESTAZIONE serie ENR 100-200

(secondo ISO 9906 Allegato A)

4 Poli

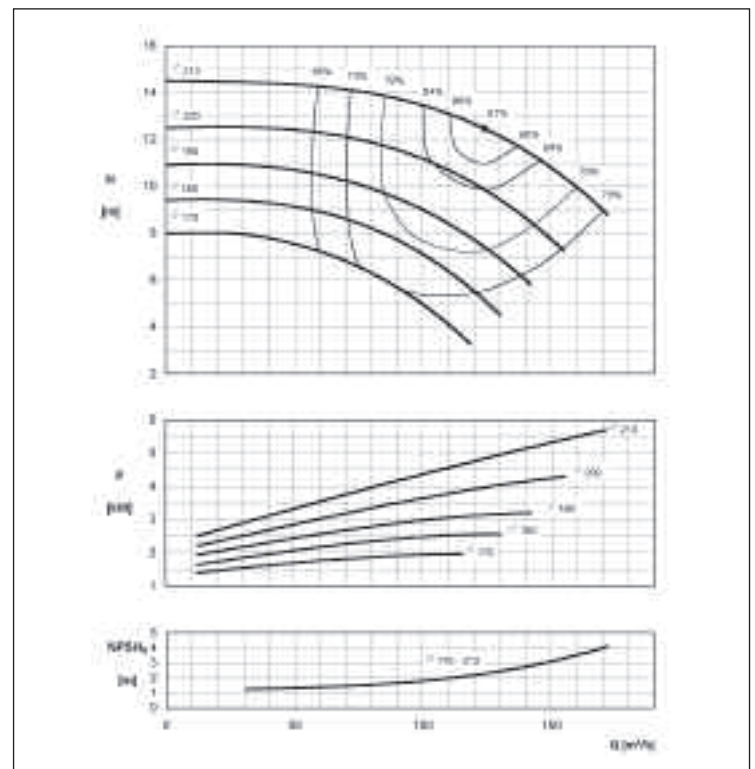
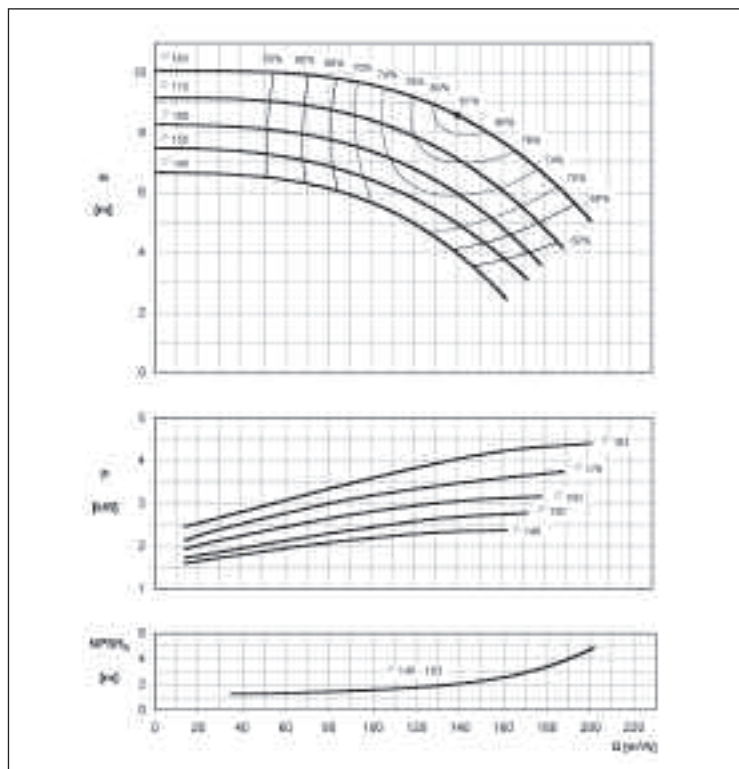

ELETTROPOMPE CENTRIFUGHE MONOBLOCCO SECONDO EN 733

in ghisa

CURVE DI PRESTAZIONE serie ENR 100-250

(secondo ISO 9906 Allegato A)

4 Poli

CURVE DI PRESTAZIONE serie ENR 100-315

(secondo ISO 9906 Allegato A)

4 Poli

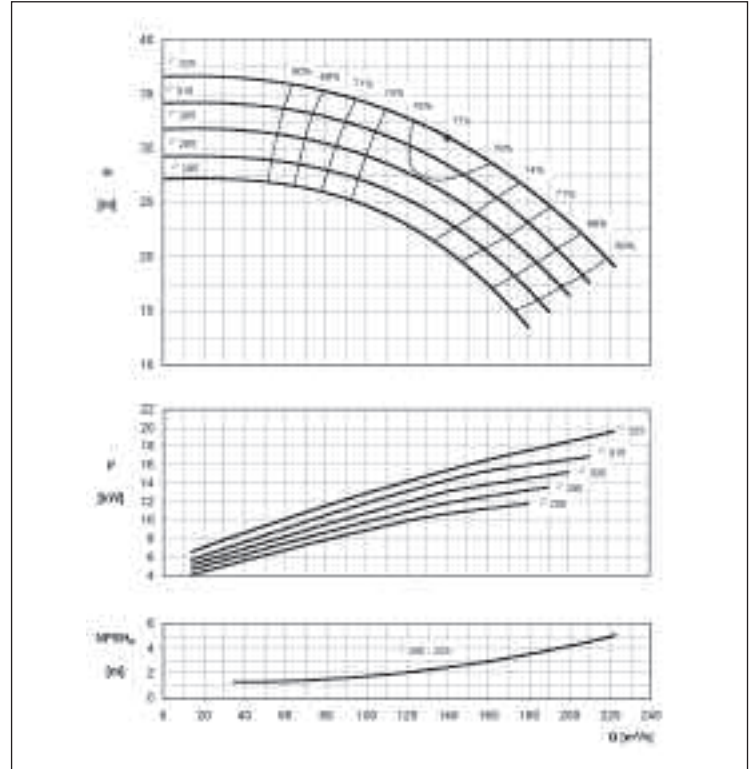
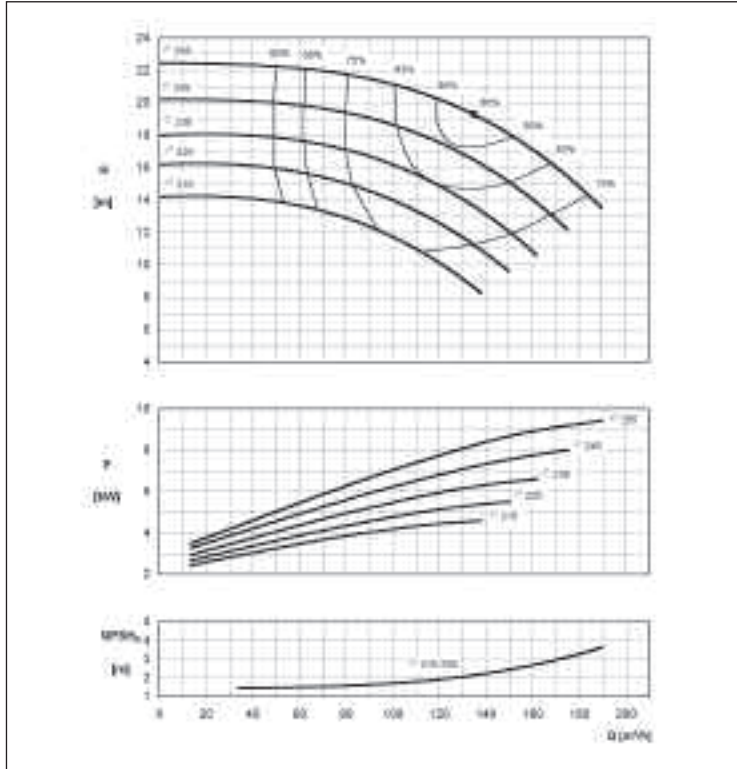

CURVE DI PRESTAZIONE serie ENR 100-400

(secondo ISO 9906 Allegato A)

4 Poli

CURVE DI PRESTAZIONE serie ENR 125-200

(secondo ISO 9906 Allegato A)

4 Poli

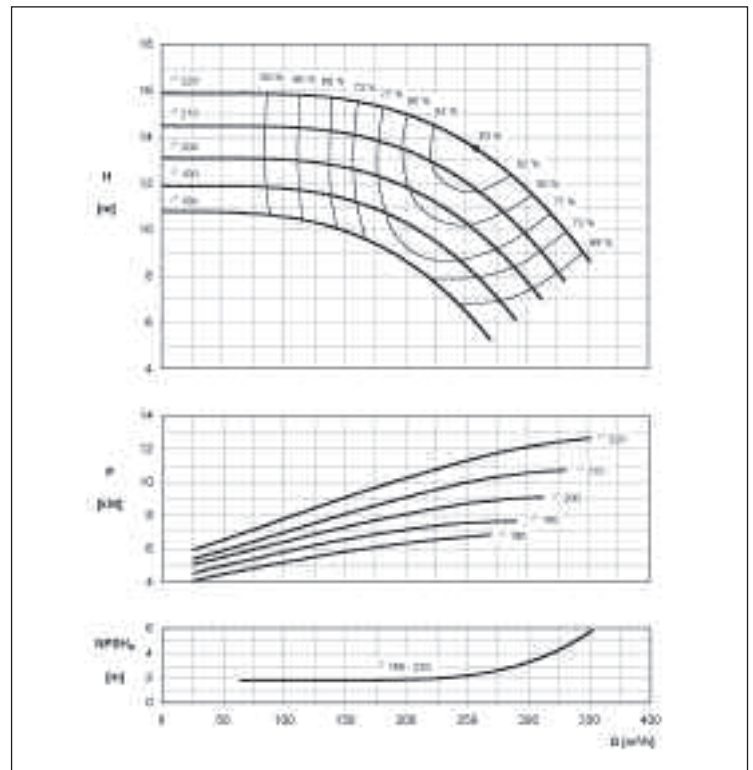
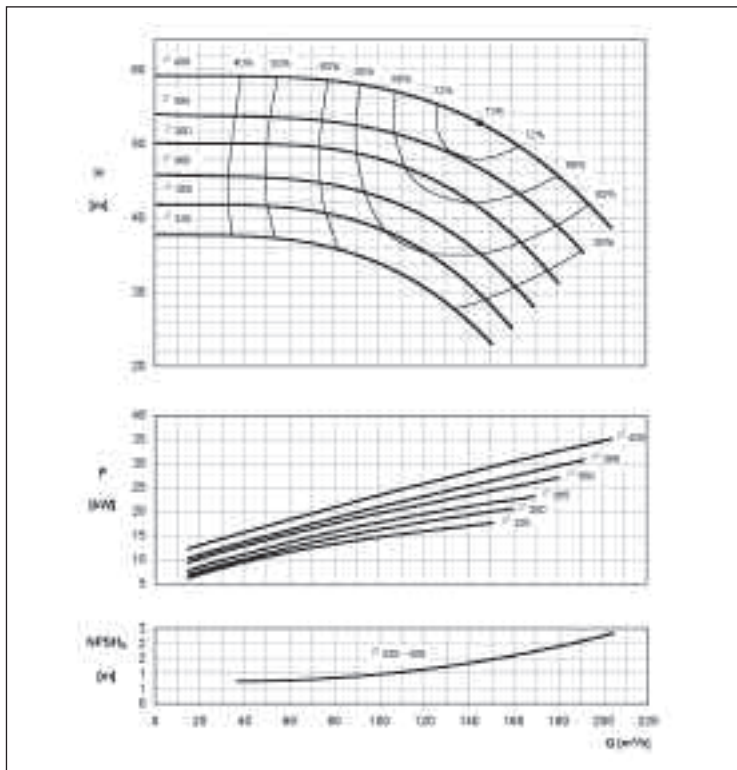

ELETTROPOMPE CENTRIFUGHE MONOBLOCCO SECONDO EN 733

in ghisa

CURVE DI PRESTAZIONE serie ENR 125-250

(secondo ISO 9906 Allegato A)

4 Poli

CURVE DI PRESTAZIONE serie ENR 125-315

(secondo ISO 9906 Allegato A)

4 Poli

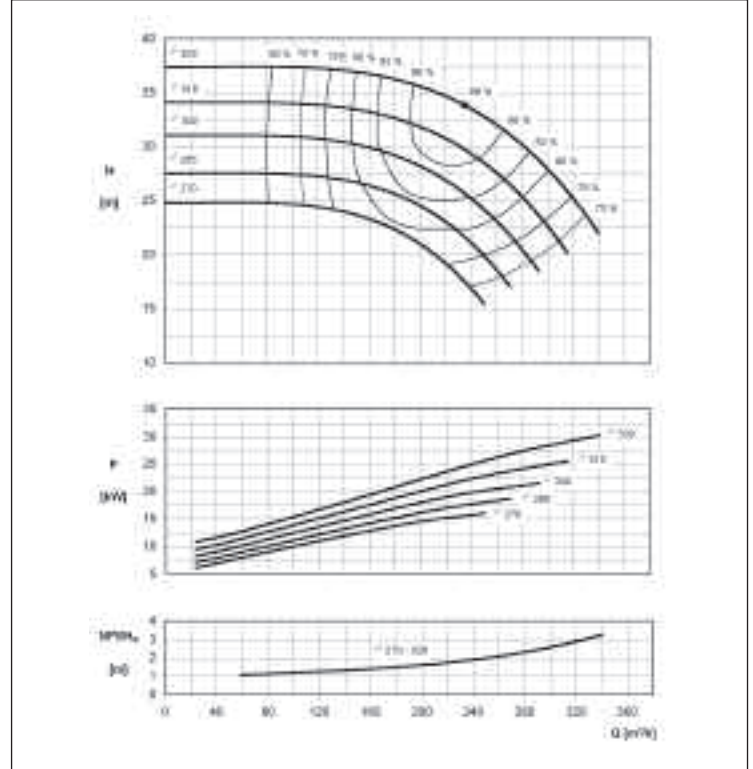
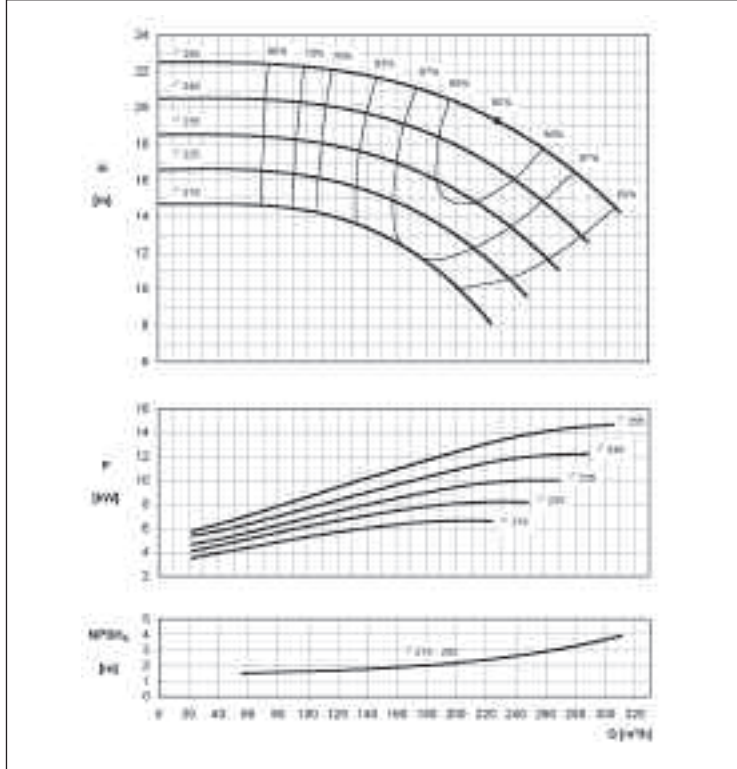

CURVE DI PRESTAZIONE serie ENR 125-400

(secondo ISO 9906 Allegato A)

4 Poli

CURVE DI PRESTAZIONE serie ENR 150-200

(secondo ISO 9906 Allegato A)

4 Poli

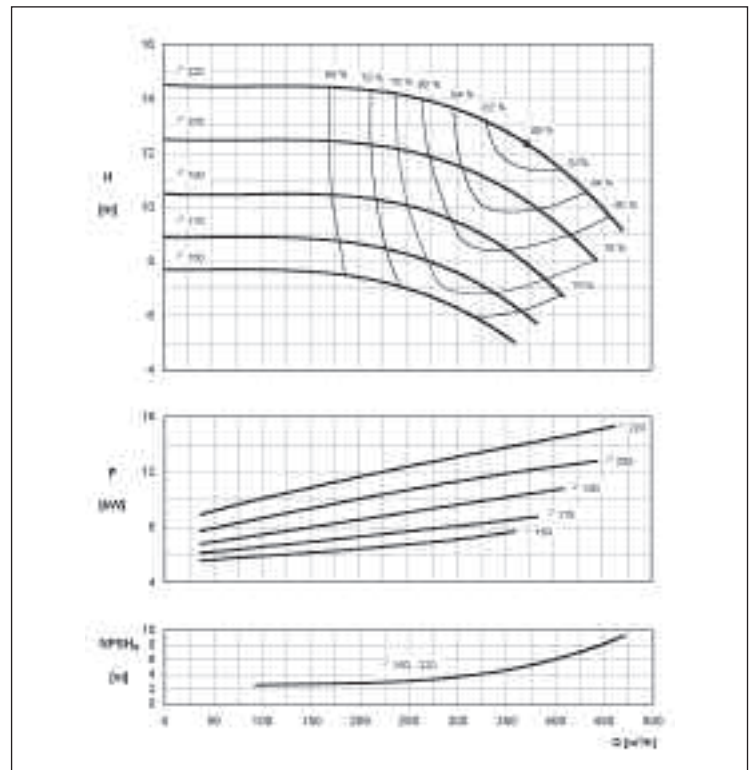
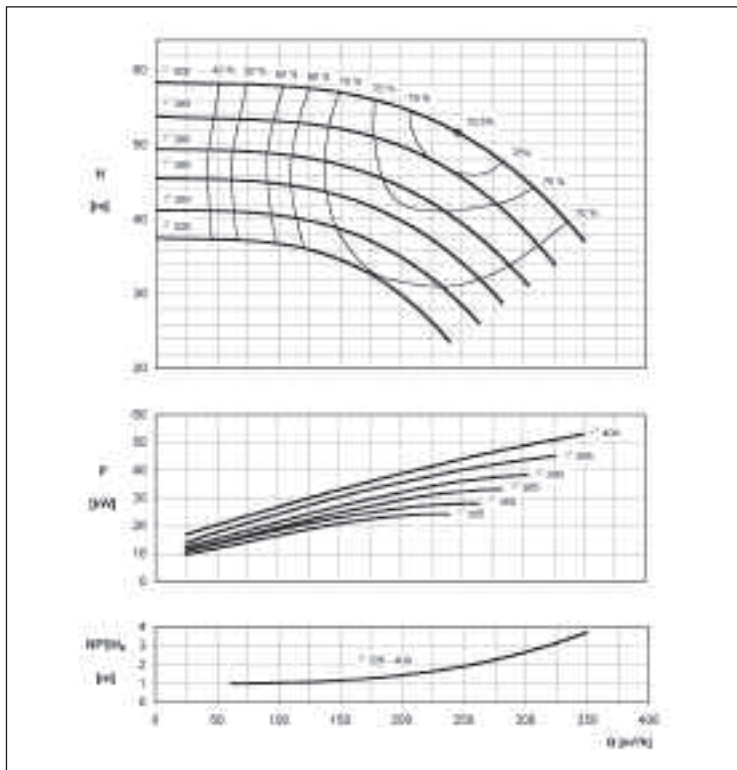

ELETTROPOMPE CENTRIFUGHE MONOBLOCCO SECONDO EN 733

in ghisa

CURVE DI PRESTAZIONE serie ENR 150-250

(secondo ISO 9906 Allegato A)

4 Poli

CURVE DI PRESTAZIONE serie ENR 150-315

(secondo ISO 9906 Allegato A)

4 Poli

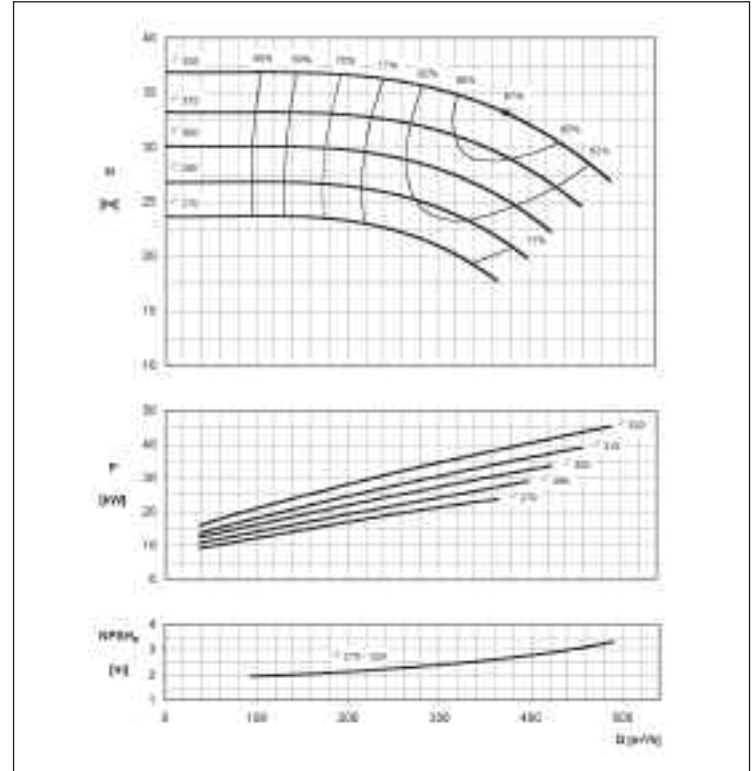
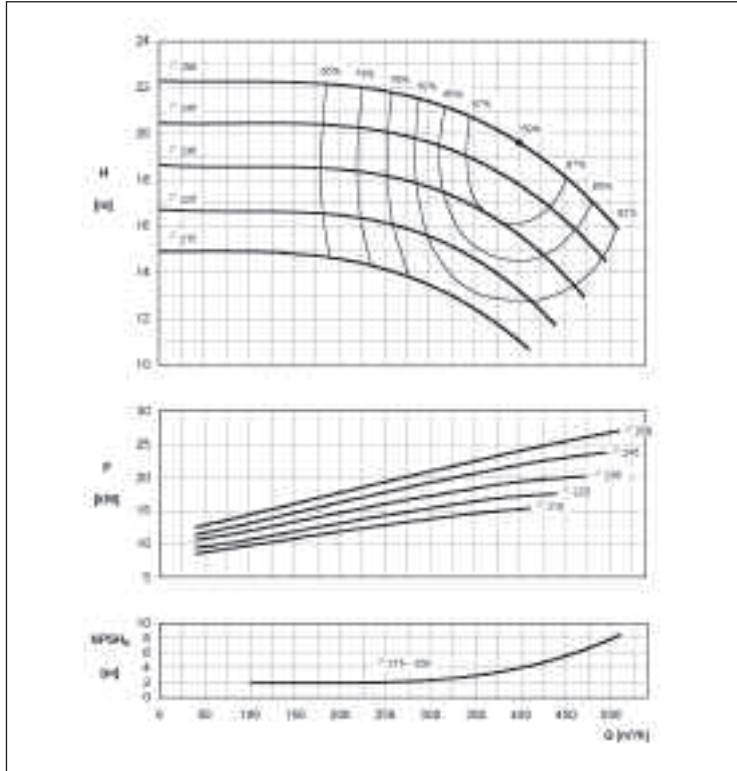

CURVE DI PRESTAZIONE serie ENR 150-400

(secondo ISO 9906 Allegato A)

4 Poli

CURVE DI PRESTAZIONE serie ENR 150-500

(secondo ISO 9906 Allegato A)

4 Poli

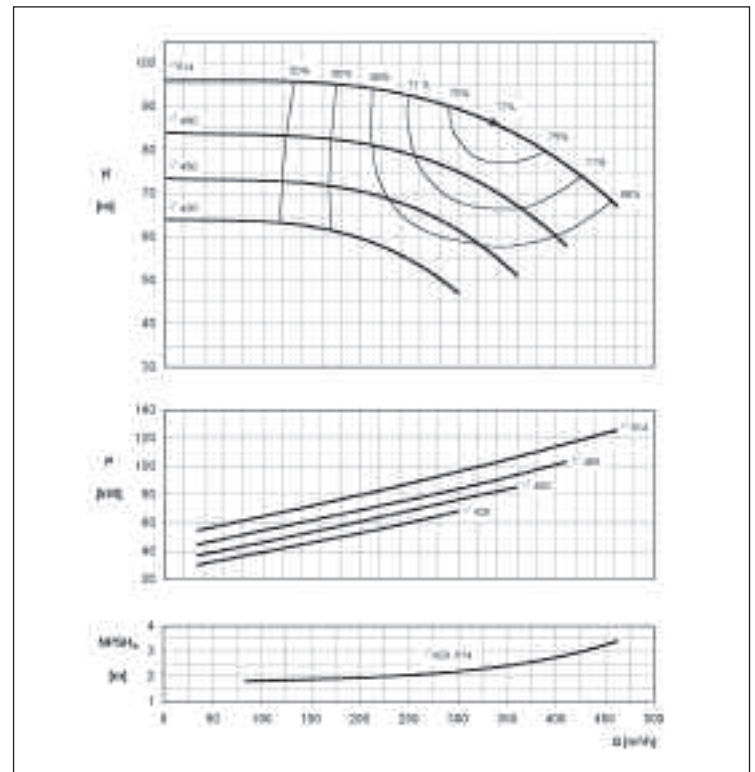
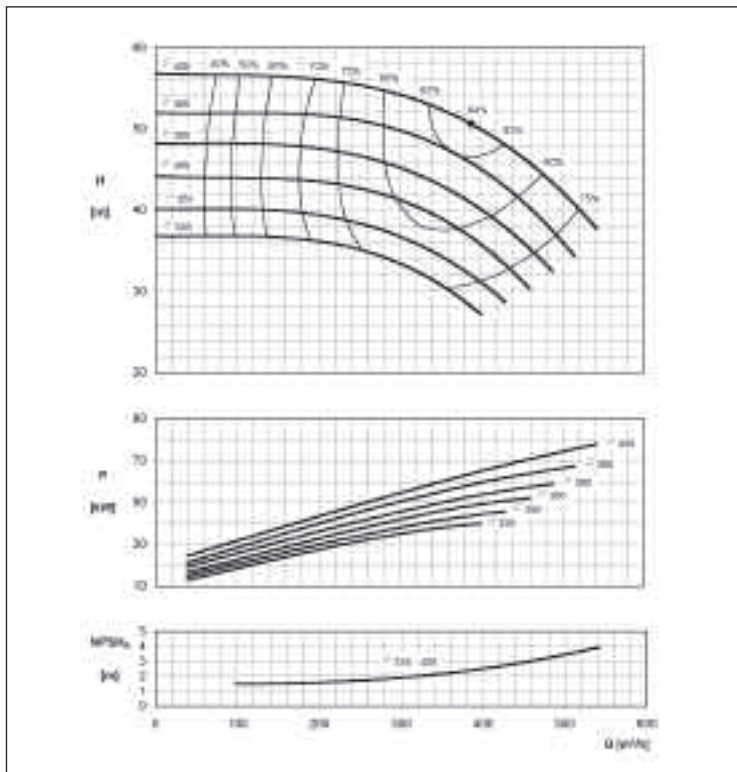

ELETTROPOMPE CENTRIFUGHE MONOBLOCCO SECONDO EN 733

in ghisa

CURVE DI PRESTAZIONE serie ENR 200-250

(secondo ISO 9906 Allegato A)

4 Poli

CURVE DI PRESTAZIONE serie ENR 200-315

(secondo ISO 9906 Allegato A)

4 Poli

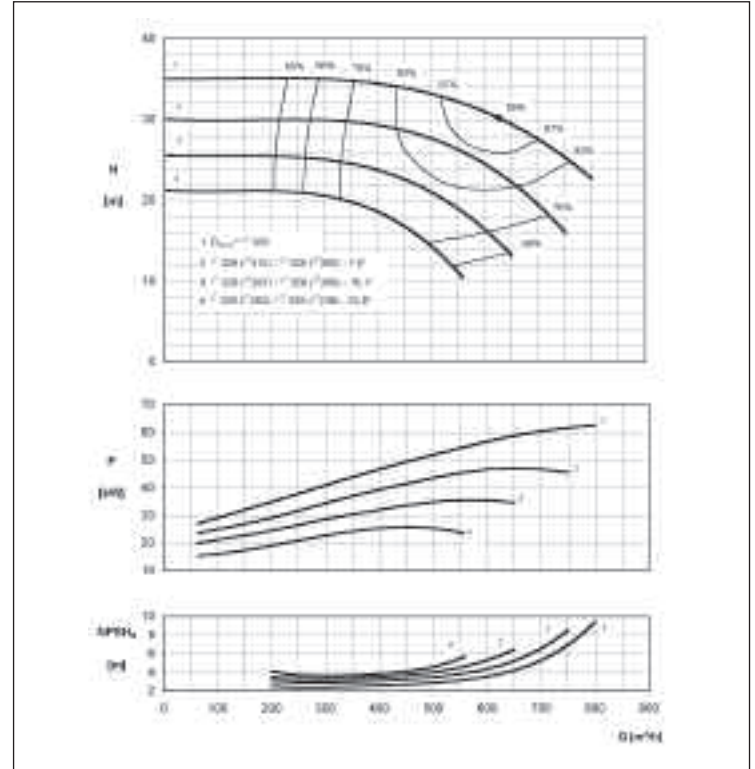
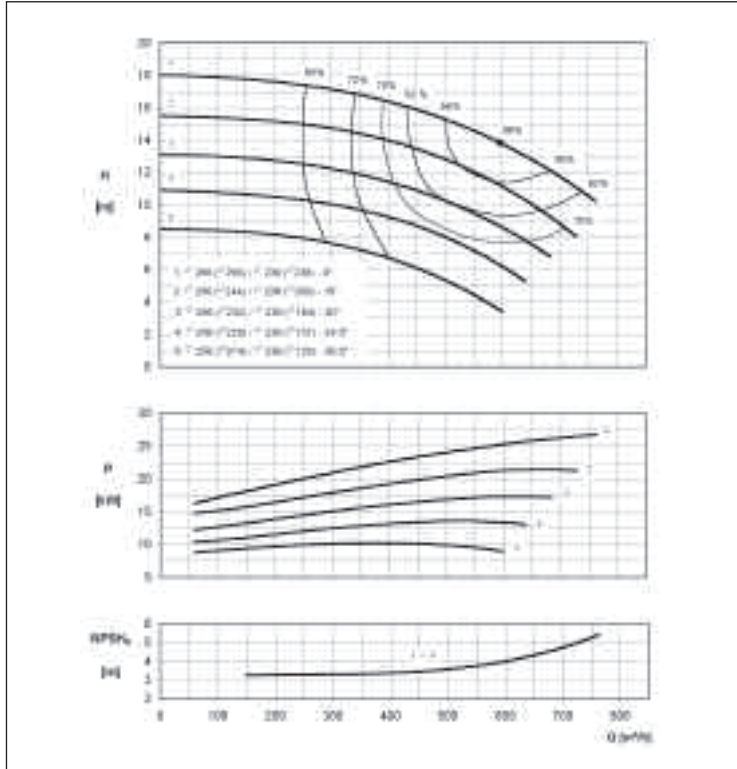

CURVE DI PRESTAZIONE serie ENR 200-400

(secondo ISO 9906 Allegato A)

4 Poli

CURVE DI PRESTAZIONE serie ENR 200-500

(secondo ISO 9906 Allegato A)

4 Poli

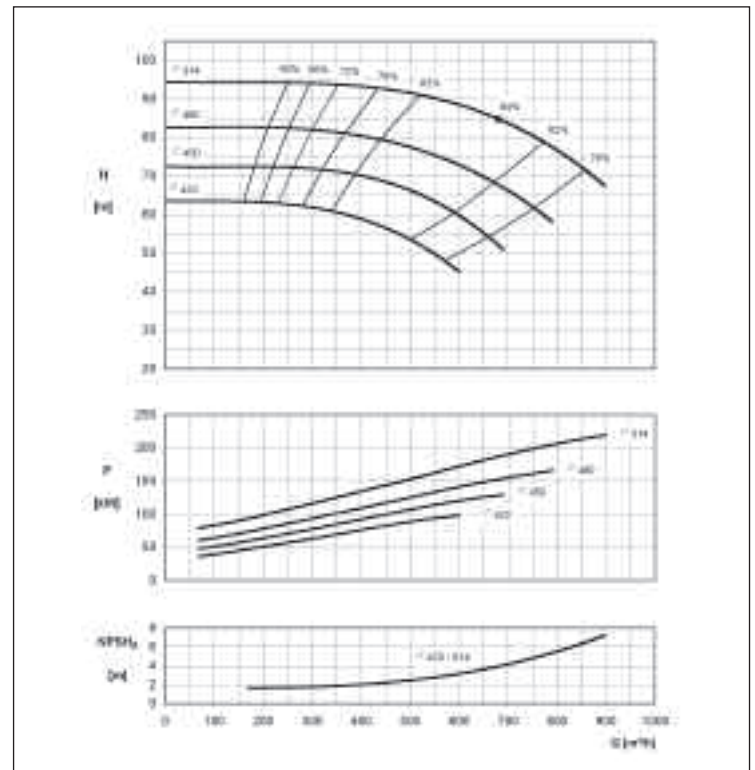
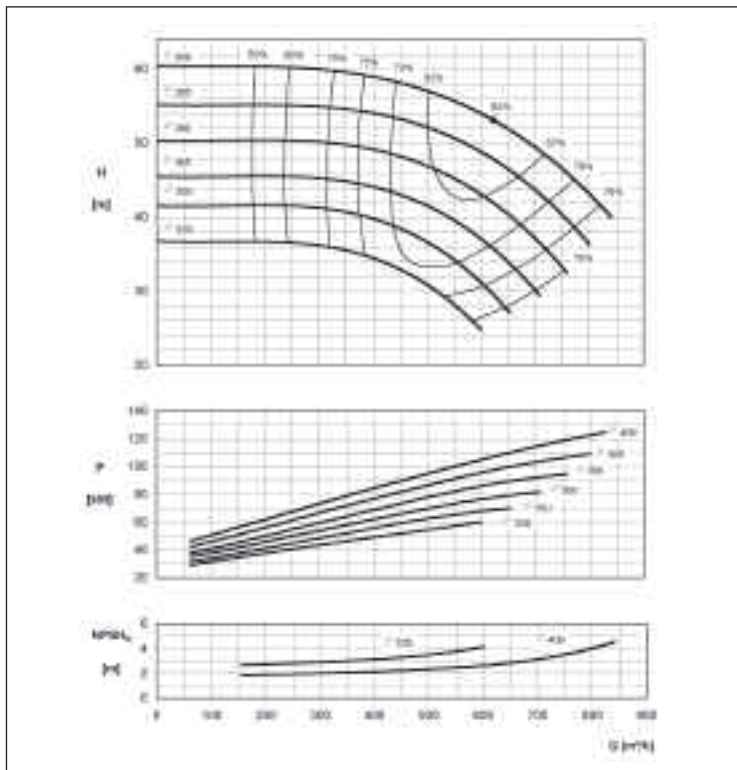

ELETTROPOMPE CENTRIFUGHE MONOBLOCCO SECONDO EN 733

in ghisa

CURVE DI PRESTAZIONE serie ENR 250-300

(secondo ISO 9906 Allegato A)

4 Poli

CURVE DI PRESTAZIONE serie ENR 250-315

(secondo ISO 9906 Allegato A)

4 Poli

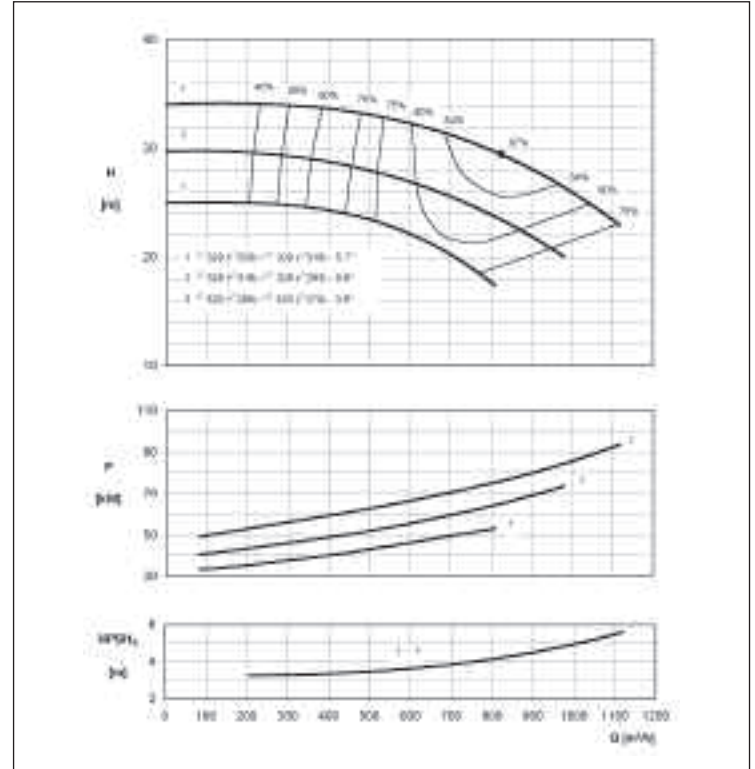
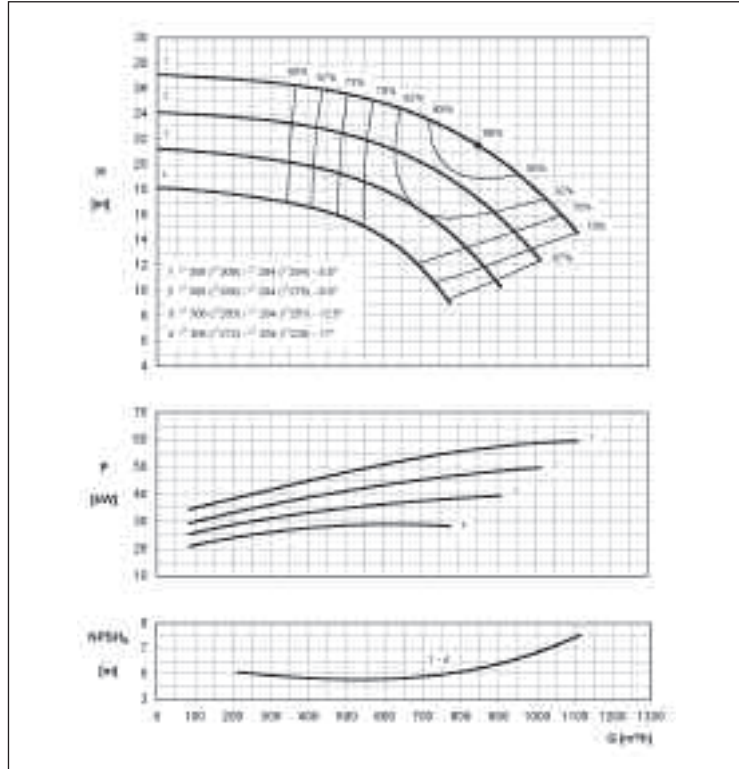

CURVE DI PRESTAZIONE serie ENR 250-400

(secondo ISO 9906 Allegato A)

4 Poli

CURVE DI PRESTAZIONE serie ENR 250-500

(secondo ISO 9906 Allegato A)

4 Poli

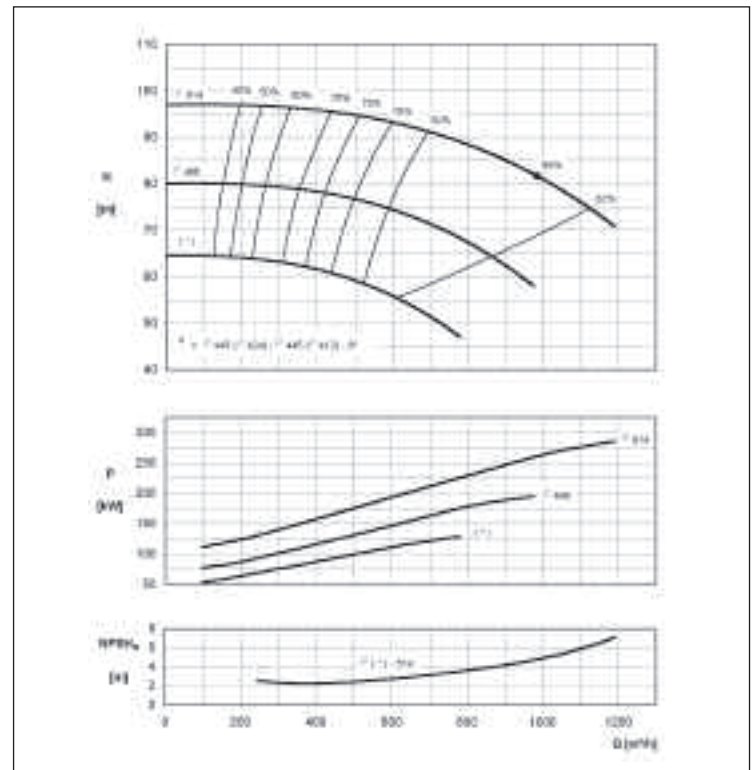
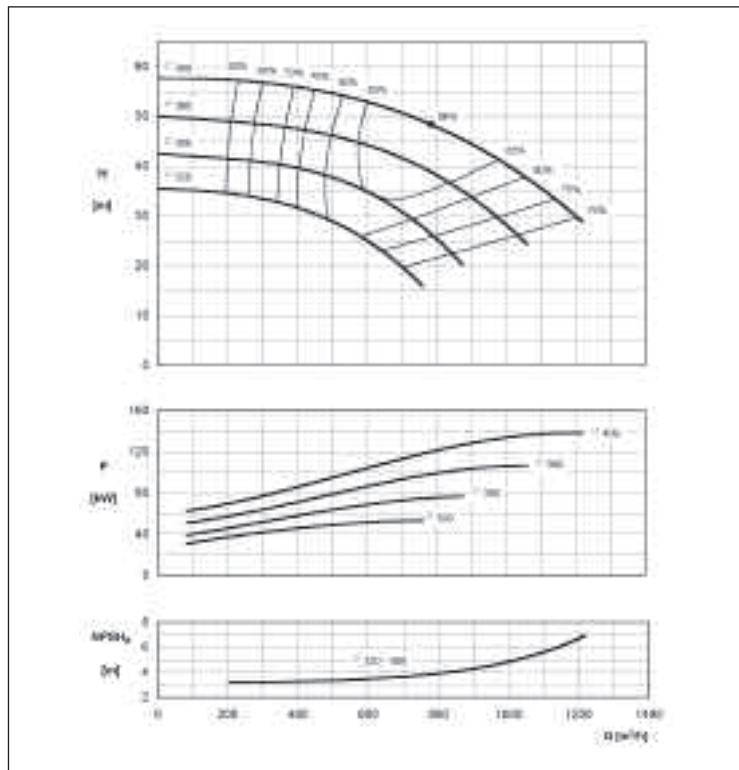

ELETTROPOMPE CENTRIFUGHE MONOBLOCCO SECONDO EN 733 in ghisa

CURVE DI PRESTAZIONE serie ENR 300-400
(secondo ISO 9906 Allegato A)

4 Poli

CURVE DI PRESTAZIONE serie ENR 300-500
(secondo ISO 9906 Allegato A)

4 Poli

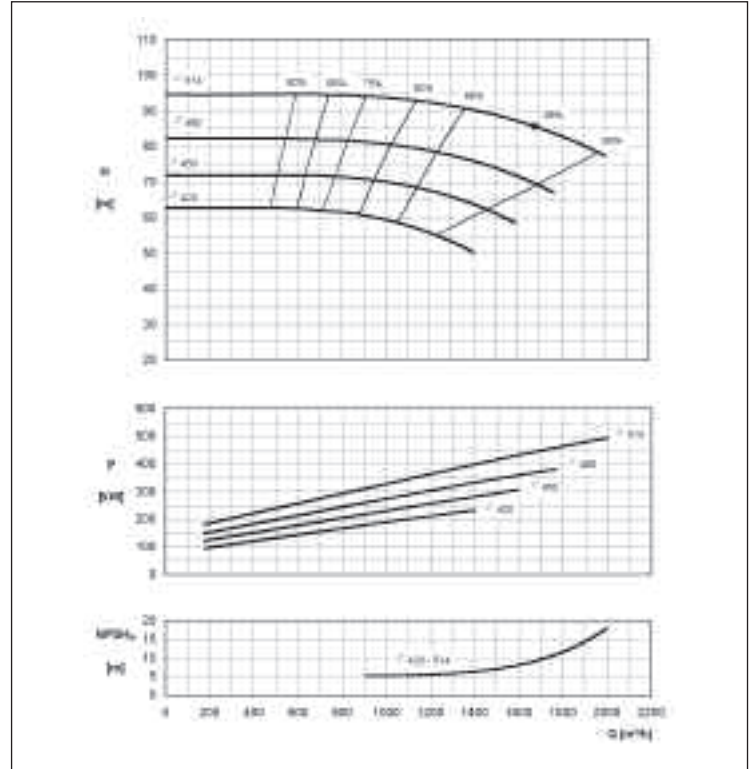
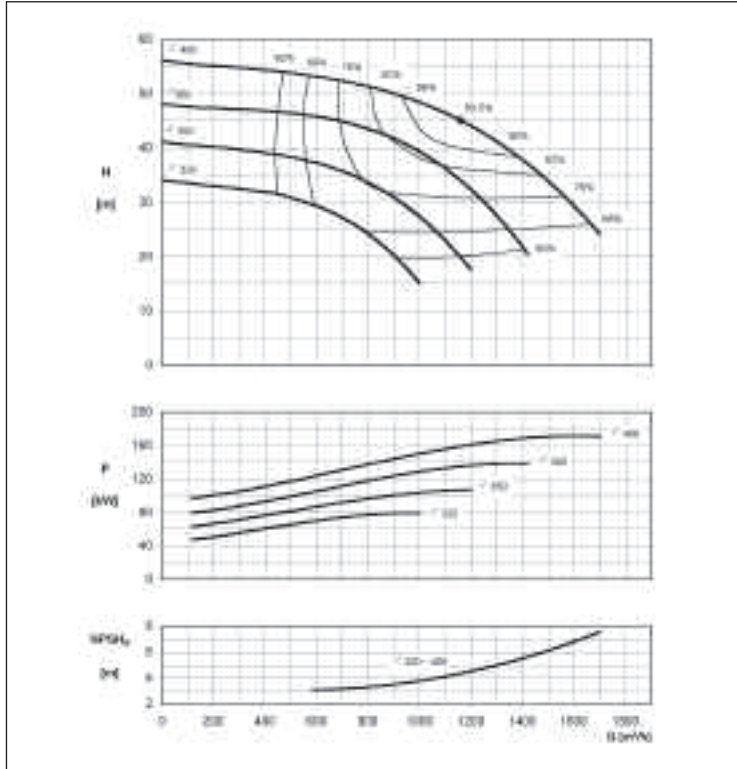

ELETTROPOMPE CENTRIFUGHE MONOBLOCCO SECONDO EN 733

in ghisa

DIMENSIONI ENR



TABELLA DIMENSIONI ENR 32-40

Modello	Motore [kW]			Dimensioni [mm]															[kg]
	2 Poli	4 Poli	Grand.	DN2	DN1	a	h2	h1	A	B	F	Y	Giunto standard						
				V									V	E	H	S	T		
ENR 32-125	-	0,37	71	32	50	80	140	112	900	390	300	150	600	350	50	18	714	70,0	
ENR 32-125	-	0,55	80	32	50	80	140	112	900	390	300	150	600	350	50	18	714	70,0	
ENR 32-125	-	0,75	80	32	50	80	140	112	900	390	300	150	600	350	50	18	714	70,0	
ENR 32-125	0,75	-	80	32	50	80	140	112	900	390	300	150	600	350	50	18	714	70,0	
ENR 32-125	1,1	-	80	32	50	80	140	112	900	390	300	150	600	350	50	18	714	70,0	
ENR 32-125	1,5	-	90S	32	50	80	140	112	900	390	300	150	600	350	50	18	764	73,0	
ENR 32-125	2,2	-	90L	32	50	80	140	112	900	390	300	150	600	350	50	18	764	76,0	
ENR 32-160	-	0,37	71	32	50	80	160	132	900	390	300	150	600	350	50	18	714	71,0	
ENR 32-160	-	0,55	80	32	50	80	160	132	900	390	300	150	600	350	50	18	714	71,0	
ENR 32-160	-	0,75	80	32	50	80	160	132	900	390	300	150	600	350	50	18	714	71,0	
ENR 32-160	1,5	-	90S	32	50	80	160	132	900	390	300	150	600	350	50	18	764	74,0	
ENR 32-160	2,2	-	90L	32	50	80	160	132	900	390	300	150	600	350	50	18	764	77,0	
ENR 32-160	3	-	100L	32	50	80	160	132	900	390	300	150	600	350	50	18	844	87,0	
ENR 32-160	4	-	112	32	50	80	160	132	900	490	380	150	600	440	50	18	844	99,0	
ENR 32-160	5,5	-	132S	32	50	80	160	132	900	490	380	150	600	440	50	18	926	110,0	
ENR 32-200	-	0,55	80	32	50	80	180	160	900	390	300	150	600	350	50	18	714	79,0	
ENR 32-200	-	0,75	80	32	50	80	180	160	900	390	300	150	600	350	50	18	714	79,0	
ENR 32-200	-	1,1	90S	32	50	80	180	160	900	390	300	150	600	350	50	18	764	82,0	
ENR 32-200	-	1,5	90L	32	50	80	180	160	900	390	300	150	600	350	50	18	764	84,0	
ENR 32-200	2,2	-	90L	32	50	80	180	160	900	390	300	150	600	350	50	18	764	84,0	
ENR 32-200	3	-	100L	32	50	80	180	160	900	390	300	150	600	350	50	18	844	91,0	
ENR 32-200	4	-	112	32	50	80	180	160	900	490	380	150	600	440	50	18	844	103,0	
ENR 32-200	5,5	-	132S	32	50	80	180	160	900	490	380	150	600	440	50	18	926	121,0	
ENR 32-200	7,5	-	132S	32	50	80	180	160	900	490	380	150	600	440	50	18	926	121,0	
ENR 32-200	11	-	160M	32	50	80	180	160	1120	490	380	190	740	440	50	22	1092	167,0	
ENR 32-250	-	0,75	80	32	50	100	225	180	900	490	380	150	600	440	50	18	734	95,0	
ENR 32-250	-	1,1	90S	32	50	100	225	180	900	490	380	150	600	440	50	18	784	98,0	
ENR 32-250	-	1,5	90L	32	50	100	225	180	900	490	380	150	600	440	50	18	784	100,0	
ENR 32-250	-	2,2	100L	32	50	100	225	180	900	490	380	150	600	440	50	18	864	111,0	
ENR 32-250	-	3	100L	32	50	100	225	180	900	490	380	150	600	440	50	18	864	111,0	
ENR 32-250	7,5	-	132S	32	50	100	225	180	900	490	380	150	600	440	50	18	946	132,0	
ENR 32-250	11	-	160M	32	50	100	225	180	1120	610	480	190	740	550	50	22	1112	187,0	
ENR 32-250	15	-	160M	32	50	100	225	180	1120	610	480	190	740	550	50	22	1112	187,0	
ENR 32-250	18,5	-	160L	32	50	100	225	180	1120	610	480	190	740	550	50	22	1112	201,0	
ENR 40-125	-	0,37	71	40	65	80	140	112	900	390	300	150	600	350	50	18	714	71,0	
ENR 40-125	-	0,55	80	40	65	80	140	112	900	390	300	150	600	350	50	18	714	71,0	
ENR 40-125	-	0,75	80	40	65	80	140	112	900	390	300	150	600	350	50	18	714	71,0	
ENR 40-125	1,1	-	80	40	65	80	140	112	900	390	300	150	600	350	50	18	714	71,0	
ENR 40-125	1,5	-	90S	40	65	80	140	112	900	390	300	150	600	350	50	18	764	74,0	
ENR 40-125	2,2	-	90L	40	65	80	140	112	900	390	300	150	600	350	50	18	764	77,0	
ENR 40-125	3	-	100L	40	65	80	140	112	900	390	300	150	600	350	50	18	844	87,0	
ENR 40-125	5,5	-	132S	40	65	80	140	132	900	490	380	150	600	440	50	18	926	114,0	

ELETTROPOMPE CENTRIFUGHE MONOBLOCCO SECONDO EN 733

in ghisa

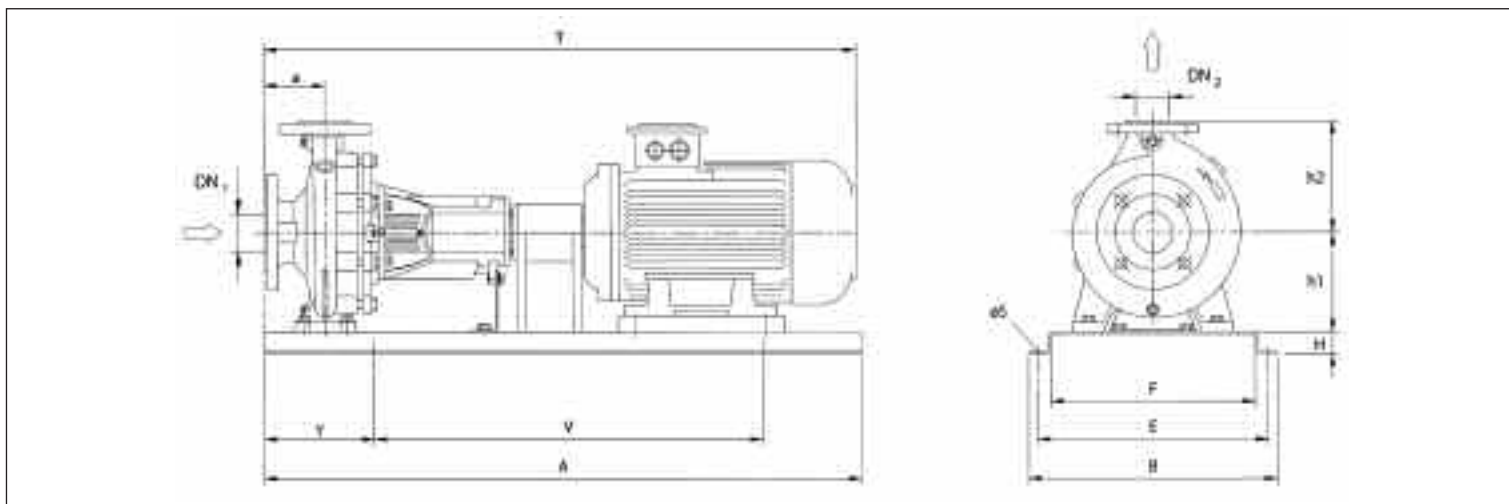
DIMENSIONI ENR 40-50

Modello	Motore [kW]		Grand.	Dimensioni [mm]									Giunto standard					[kg]
	2 Poli	4 Poli		DN2	DN1	a	h2	h1	A	B	F	Y	V	E	H	S	T	
ENR 40-160	-	0,37	71	40	65	80	160	132	900	390	300	150	600	350	50	18	714	77,0
ENR 40-160	-	0,55	80	40	65	80	160	132	900	390	300	150	600	350	50	18	714	77,0
ENR 40-160	-	0,75	80	40	65	80	160	132	900	390	300	150	600	350	50	18	714	77,0
ENR 40-160	-	1,1	90S	40	65	80	160	132	900	390	300	150	600	350	50	18	764	80,0
ENR 40-160	-	1,5	90L	40	65	80	160	132	900	390	300	150	600	350	50	18	764	82,0
ENR 40-160	1,5	-	90S	40	65	80	160	132	900	390	300	150	600	350	50	18	764	82,0
ENR 40-160	2,2	-	90L	40	65	80	160	132	900	390	300	150	600	350	50	18	764	83,0
ENR 40-160	3	-	100L	40	65	80	160	132	900	390	300	150	600	350	50	18	844	93,0
ENR 40-160	4	-	112	40	65	80	160	132	900	490	380	150	600	440	50	18	844	104,0
ENR 40-160	5,5	-	132S	40	65	80	160	132	900	490	380	150	600	440	50	18	926	115,0
ENR 40-200	-	0,55	80	40	65	100	180	160	900	490	380	150	600	440	50	18	734	84,0
ENR 40-200	-	0,75	80	40	65	100	180	160	900	490	380	150	600	440	50	18	734	84,0
ENR 40-200	-	1,1	90S	40	65	100	180	160	900	490	380	150	600	440	50	18	784	87,0
ENR 40-200	-	1,5	90L	40	65	100	180	160	900	490	380	150	600	440	50	18	784	89,0
ENR 40-200	3	-	100L	40	65	100	180	160	900	490	380	150	600	440	50	18	864	97,0
ENR 40-200	4	-	112	40	65	100	180	160	900	490	380	150	600	440	50	18	864	106,0
ENR 40-200	5,5	-	132S	40	65	100	180	160	900	490	380	150	600	440	50	18	946	121,0
ENR 40-200	7,5	-	132S	40	65	100	180	160	900	490	380	150	600	440	50	18	946	121,0
ENR 40-200	11	-	160M	40	65	100	180	160	1120	490	380	190	740	440	50	22	1112	167,0
ENR 40-200	15	-	160M	40	65	100	180	160	1120	490	380	190	740	440	50	22	1112	167,0
ENR 40-250	-	1,1	90S	40	65	100	225	180	900	490	380	150	600	440	50	18	784	98,0
ENR 40-250	-	1,5	90L	40	65	100	225	180	900	490	380	150	600	440	50	18	784	100,0
ENR 40-250	-	2,2	100L	40	65	100	225	180	900	490	380	150	600	440	50	18	864	111,0
ENR 40-250	-	3	100L	40	65	100	225	180	900	490	380	150	600	440	50	18	864	111,0
ENR 40-250	7,5	-	132S	40	65	100	225	180	900	490	380	150	600	440	50	18	946	12,0
ENR 40-250	11	-	160M	40	65	100	225	180	1120	490	380	190	740	440	50	22	1112	178,0
ENR 40-250	15	-	160M	40	65	100	225	180	1120	490	380	190	740	440	50	22	1112	178,0
ENR 40-250	18,5	-	160L	40	65	100	225	180	1120	610	480	190	740	550	50	22	1112	201,0
ENR 40-250	22	-	180M	40	65	100	225	180	1120	610	480	190	740	550	50	22	1150	224,0
ENR 40-315	-	2,2	100L	40	65	125	250	225	1120	610	480	190	740	550	50	22	999	171,0
ENR 40-315	-	3	100L	40	65	125	250	225	1120	610	480	190	740	550	50	22	999	171,0
ENR 40-315	-	4	112	40	65	125	250	225	1120	610	480	190	740	550	50	22	999	178,0
ENR 40-315	-	5,5	132S	40	65	125	250	225	1120	610	480	190	740	550	50	22	1081	189,0
ENR 40-315	15	-	160M	40	65	125	250	225	1400	610	480	230	940	550	75	26	1247	242,0
ENR 40-315	18,5	-	160L	40	65	125	250	225	1400	610	480	230	940	550	75	26	1247	256,0
ENR 40-315	22	-	180M	40	65	125	250	225	1400	610	480	230	940	550	75	26	1285	280,0
ENR 40-315	30	-	200L	40	65	125	250	225	1400	610	480	230	940	550	75	26	1322	345,0
ENR 40-315	37	-	200L	40	65	125	250	225	1400	610	480	230	940	550	75	26	1322	345,0
ENR 50-125	-	0,37	71	50	65	100	160	132	900	390	300	150	600	350	50	18	734	77,0
ENR 50-125	-	0,55	80	50	65	100	160	132	900	390	300	150	600	350	50	18	734	77,0
ENR 50-125	-	0,75	80	50	65	100	160	132	900	390	300	150	600	350	50	18	734	77,0
ENR 50-125	-	1,1	90S	50	65	100	160	132	900	390	300	150	600	350	50	18	784	80,0
ENR 50-125	1,5	-	90S	50	65	100	160	132	900	390	300	150	600	350	50	18	784	82,0
ENR 50-125	2,2	-	90L	50	65	100	160	132	900	390	300	150	600	350	50	18	784	83,0
ENR 50-125	3	-	100L	50	65	100	160	132	900	390	300	150	600	350	50	18	864	93,0
ENR 50-125	4	-	112	50	65	100	160	132	900	490	380	150	600	440	50	18	864	104,0
ENR 50-125	5,5	-	132S	50	65	100	160	132	900	490	380	150	600	440	50	18	946	115,0
ENR 50-125	7,5	-	132S	50	65	100	160	132	900	490	380	150	600	440	50	18	946	115,0
ENR 50-160	-	0,55	80	50	65	100	180	160	900	490	380	150	600	440	50	18	734	82,0
ENR 50-160	-	0,75	80	50	65	100	180	160	900	490	380	150	600	440	50	18	734	82,0
ENR 50-160	-	1,1	90S	50	65	100	180	160	900	490	380	150	600	440	50	18	784	85,0
ENR 50-160	-	2,2	100L	50	65	100	180	160	900	490	380	150	600	440	50	18	864	97,0
ENR 50-160	2,2	-	90L	50	65	100	180	160	900	490	380	150	600	440	50	18	784	87,0
ENR 50-160	3	-	100L	50	65	100	180	160	900	490	380	150	600	440	50	18	864	97,0
ENR 50-160	4	-	112	50	65	100	180	160	900	490	380	150	600	440	50	18	864	103,0
ENR 50-160	5,5	-	132S	50	65	100	180	160	900	490	380	150	600	440	50	18	946	119,0
ENR 50-160	7,5	-	132S	50	65	100	180	160	900	490	380	150	600	440	50	18	946	119,0
ENR 50-160	11	-	160M	50	65	100	180	160	1120	490	380	190	740	440	50	22	1112	165,0
ENR 50-160	15	-	160M	50	65	100	180	180	1120	490	380	190	740	440	50	22	1112	165,0

ELETTROPOMPE CENTRIFUGHE MONOBLOCCO SECONDO EN 733

in ghisa

DIMENSIONI ENR 50-65

Modello	Motore [kW]		Grand.	Dimensioni [mm]									Giunto standard					[kg]
	2 Poli	4 Poli		DN2	DN1	a	h2	h1	A	B	F	Y	V	E	H	S	T	
ENR 50-200	-	1,1	90S	50	65	100	200	160	900	490	380	150	600	440	50	18	784	89,0
ENR 50-200	-	1,5	90L	50	65	100	200	160	900	490	380	150	600	440	50	18	784	92,0
ENR 50-200	-	2,2	100L	50	65	100	200	160	900	490	380	150	600	440	50	18	864	102,0
ENR 50-200	-	3	100L	50	65	100	200	160	900	490	380	150	600	440	50	18	864	102,0
ENR 50-200	-	4	112	50	65	100	200	160	900	490	380	150	600	440	50	18	864	109,0
ENR 50-200	3	-	100L	50	65	100	200	160	900	490	380	150	600	440	50	18	864	102,0
ENR 50-200	4	-	112	50	65	100	200	160	900	490	380	150	600	440	50	18	864	109,0
ENR 50-200	5,5	-	132S	50	65	100	200	160	900	490	380	150	600	440	50	18	946	123,0
ENR 50-200	7,5	-	132S	50	65	100	200	160	900	490	380	150	600	440	50	18	946	123,0
ENR 50-200	11	-	160M	50	65	100	200	160	1120	490	380	190	740	440	50	22	1112	169,0
ENR 50-200	15	-	160M	50	65	100	200	160	1120	490	380	190	740	440	50	22	1112	169,0
ENR 50-200	18,5	-	160L	50	65	100	200	160	1120	490	380	190	740	440	50	22	1112	183,0
ENR 50-200	22	-	180M	50	65	100	200	180	1120	610	480	190	740	550	50	22	1150	217,0
ENR 50-250	-	1,5	90L	50	65	100	225	180	900	490	380	150	600	440	50	18	784	107,0
ENR 50-250	-	2,2	100L	50	65	100	225	180	900	490	380	150	600	440	50	18	864	117,0
ENR 50-250	-	3	100L	50	65	100	225	180	900	490	380	150	600	440	50	18	864	117,0
ENR 50-250	-	4	112	50	65	100	225	180	900	490	380	150	600	440	50	18	864	123,0
ENR 50-250	-	5,5	132S	50	65	100	225	180	900	490	380	150	600	440	50	18	946	138,0
ENR 50-250	15	-	160M	50	65	100	225	180	1120	610	480	190	740	550	50	22	1112	194,0
ENR 50-250	18,5	-	160L	50	65	100	225	180	1120	610	480	190	740	550	50	22	1112	207,0
ENR 50-250	22	-	180M	50	65	100	225	180	1120	610	480	190	740	550	50	22	1150	232,0
ENR 50-250	30	-	200L	50	65	100	225	200	1120	610	480	190	740	550	50	22	1187	296,0
ENR 50-315	-	3	100L	50	65	125	280	225	1120	610	480	190	740	550	50	22	999	171,0
ENR 50-315	-	4	112	50	65	125	280	225	1120	610	480	190	740	550	50	22	999	178,0
ENR 50-315	-	5,5	132S	50	65	125	280	225	1120	610	480	190	740	550	50	22	1081	189,0
ENR 50-315	-	7,5	132M	50	65	125	280	225	1120	610	480	190	740	550	50	22	1081	199,0
ENR 50-315	22	-	180M	50	65	125	280	225	1400	610	480	230	940	550	75	26	1285	280,0
ENR 50-315	30	-	200L	50	65	125	280	225	1400	610	480	230	940	550	75	26	1322	345,0
ENR 50-315	37	-	200L	50	65	125	280	225	1400	610	480	230	940	550	75	26	1322	345,0
ENR 50-315	45	-	225M	50	65	125	280	225	1400	730	600	230	940	670	75	26	1429	404,0
ENR 50-315	55	-	250M	50	65	125	280	250	1600	660	530	270	1060	600	75	26	1429	438,0
ENR 50-315	75	-	280S	50	65	125	280	280	1800	730	600	300	1200	670	100	26	1559	572,0
ENR 65-125	-	0,55	80	65	80	100	180	160	900	490	380	150	600	440	50	18	734	80,0
ENR 65-125	-	0,75	80	65	80	100	180	160	900	490	380	150	600	440	50	18	734	80,0
ENR 65-125	-	1,1	90S	65	80	100	180	160	900	490	380	150	600	440	50	18	784	83,0
ENR 65-125	3	-	100L	65	80	100	180	160	900	490	380	150	600	440	50	18	864	95,0
ENR 65-125	4	-	112	65	80	100	180	160	900	490	380	150	600	440	50	18	864	102,0
ENR 65-125	5,5	-	132S	65	80	100	180	160	900	490	380	150	600	440	50	18	946	117,0
ENR 65-125	7,5	-	132S	65	80	100	180	160	900	490	380	150	600	440	50	18	946	117,0
ENR 65-125	11	-	160M	65	80	100	180	160	1120	490	380	190	740	440	50	22	1112	163,0
ENR 65-160	-	0,75	80	65	80	100	200	160	900	490	380	150	600	440	50	18	734	85,0
ENR 65-160	-	1,1	90S	65	80	100	200	160	900	490	380	150	600	440	50	18	784	88,0
ENR 65-160	-	1,5	90L	65	80	100	200	160	900	490	380	150	600	440	50	18	784	90,0
ENR 65-160	-	2,2	100L	65	80	100	200	160	900	490	380	150	600	440	50	18	864	100,0
ENR 65-160	5,5	-	132S	65	80	100	200	160	900	490	380	150	600	440	50	18	946	122,0
ENR 65-160	7,5	-	132S	65	80	100	200	160	900	490	380	150	600	440	50	18	946	122,0
ENR 65-160	11	-	160M	65	80	100	200	160	1120	490	380	190	740	440	50	22	1112	168,0
ENR 65-160	15	-	160M	65	80	100	200	160	1120	490	380	190	740	440	50	22	1112	168,0
ENR 65-160	18,5	-	160L	65	80	100	200	160	1120	490	380	190	740	440	50	22	1112	182,0
ENR 65-200	-	1,1	90S	65	80	100	225	180	900	490	380	150	600	440	50	18	784	98,0
ENR 65-200	-	1,5	90L	65	80	100	225	180	900	490	380	150	600	440	50	18	784	100,0
ENR 65-200	-	2,2	100L	65	80	100	225	180	900	490	380	150	600	440	50	18	864	110,0
ENR 65-200	-	3	100L	65	80	100	225	180	900	490	380	150	600	440	50	18	864	110,0
ENR 65-200	-	4	112	65	80	100	225	180	900	490	380	150	600	440	50	18	864	116,0
ENR 65-200	-	5,5	132S	65	80	100	225	180	900	490	380	150	600	440	50	18	946	131,0
ENR 65-200	11	-	160M	65	80	100	225	180	1120	610	480	190	740	550	50	22	1112	186,0
ENR 65-200	15	-	160M	65	80	100	225	180	1120	610	480	190	740	550	50	22	1112	186,0
ENR 65-200	18,5	-	160L	65	80	100	225	180	1120	610	480	190	740	550	50	22	1112	200,0
ENR 65-200	22	-	180M	65	80	100	225	180	1120	610	480	190	740	550	50	22	1150	225,0
ENR 65-200	30	-	200L	65	80	100	225	200	1120	610	480	190	740	550	50	22	1187	288,0

ELETTROPOMPE CENTRIFUGHE MONOBLOCCO SECONDO EN 733

in ghisa

DIMENSIONI ENR 65-80

Modello	Motore [kW]		Grand.	Dimensioni [mm]									Giunto standard					[kg]
	2 Poli	4 Poli		DN2	DN1	a	h2	h1	A	B	F	Y	V	E	H	S	T	
ENR 65-250	-	2,2	100L	65	80	100	250	200	1120	610	480	190	740	550	50	22	974	163,0
ENR 65-250	-	3	100L	65	80	100	250	200	1120	610	480	190	740	550	50	22	974	163,0
ENR 65-250	-	4	112	65	80	100	250	200	1120	610	480	190	740	550	50	22	974	169,0
ENR 65-250	-	5,5	132S	65	80	100	250	200	1120	610	480	190	740	550	50	22	1056	184,0
ENR 65-250	-	7,5	132M	65	80	100	250	200	1120	610	480	190	740	550	50	22	1056	194,0
ENR 65-250	18,5	-	160L	65	80	100	250	200	1400	610	480	230	940	550	75	26	1222	249,0
ENR 65-250	22	-	180M	65	80	100	250	200	1400	610	480	230	940	550	75	26	1260	273,0
ENR 65-250	30	-	200L	65	80	100	250	200	1400	610	480	230	940	550	75	26	1297	337,0
ENR 65-250	37	-	200L	65	80	100	250	200	1400	610	480	230	940	550	75	26	1297	337,0
ENR 65-250	45	-	225M	65	80	100	250	225	1400	730	600	230	940	670	75	26	1404	396,0
ENR 65-315	-	5,5	132S	65	80	125	280	225	1120	610	480	190	740	550	50	22	1081	203,0
ENR 65-315	-	7,5	132M	65	80	125	280	225	1120	610	480	190	740	550	50	22	1081	211,0
ENR 65-315	-	11	160M	65	80	125	280	225	1400	610	480	230	940	550	75	26	1247	254,0
ENR 65-315	-	15	160L	65	80	125	280	225	1400	610	480	230	940	550	75	26	1247	268,0
ENR 80-160	-	0,75	80	80	100	125	225	180	900	490	380	150	600	440	50	18	759	90,0
ENR 80-160	-	1,1	90S	80	100	125	225	180	900	490	380	150	600	440	50	18	809	93,0
ENR 80-160	-	1,5	90L	80	100	125	225	180	900	490	380	150	600	440	50	18	809	95,0
ENR 80-160	-	2,2	100L	80	100	125	225	180	900	490	380	150	600	440	50	18	889	105,0
ENR 80-160	-	3	100L	80	100	125	225	180	900	490	380	150	600	440	50	18	889	105,0
ENR 80-160	-	4	112	80	100	125	225	180	900	490	380	150	600	440	50	18	889	112,0
ENR 80-160	7,5	-	132S	80	100	125	225	180	1120	490	380	190	740	440	50	22	971	143,0
ENR 80-160	11	-	160M	80	100	125	225	180	1120	610	480	190	740	550	50	22	1137	182,0
ENR 80-160	15	-	160M	80	100	125	225	180	1120	610	480	190	740	550	50	22	1137	182,0
ENR 80-160	18,5	-	160L	80	100	125	225	180	1120	610	480	190	740	550	50	22	1137	196,0
ENR 80-160	22	-	180M	80	100	125	225	180	1120	610	480	190	740	550	50	22	1175	220,0
ENR 80-160	30	-	200L	80	100	125	225	200	1120	610	480	190	740	550	50	22	1212	284,0
ENR 80-200	-	2,2	100L	80	100	125	250	180	1120	610	480	190	740	550	50	22	999	152,0
ENR 80-200	-	3	100L	80	100	125	250	180	1120	610	480	190	740	550	50	22	999	152,0
ENR 80-200	-	4	112	80	100	125	250	180	1120	610	480	190	740	550	50	22	999	159,0
ENR 80-200	-	5,5	132S	80	100	125	250	180	1120	610	480	190	740	550	50	22	1081	170,0
ENR 80-200	15	-	160M	80	100	125	250	180	1400	610	480	230	940	550	75	26	1247	224,0
ENR 80-200	18,5	-	160L	80	100	125	250	180	1400	610	480	230	940	550	75	26	1247	238,0
ENR 80-200	22	-	180M	80	100	125	250	180	1400	610	480	230	940	550	75	26	1285	262,0
ENR 80-200	30	-	200L	80	100	125	250	200	1400	610	480	230	940	550	75	26	1322	327,0
ENR 80-200	37	-	200L	80	100	125	250	200	1400	610	480	230	940	550	75	26	1322	327,0
ENR 80-200	45	-	225M	80	100	125	250	225	1400	730	600	230	940	670	75	26	1429	385,0
ENR 80-250	-	3	100L	80	100	125	280	200	1120	610	480	190	740	550	50	22	999	167,0
ENR 80-250	-	4	112	80	100	125	280	200	1120	610	480	190	740	550	50	22	999	174,0
ENR 80-250	-	5,5	132S	80	100	125	280	200	1120	610	480	190	740	550	50	22	1081	185,0
ENR 80-250	-	7,5	132M	80	100	125	280	200	1120	610	480	190	740	550	50	22	1081	193,0
ENR 80-250	-	11	160M	80	100	125	280	200	1400	610	480	230	940	550	75	26	1247	236,0
ENR 80-250	22	-	180M	80	100	125	280	200	1400	610	480	230	940	550	75	26	1285	275,0
ENR 80-250	30	-	200L	80	100	125	280	200	1400	610	480	230	940	550	75	26	1322	338,0
ENR 80-250	37	-	200L	80	100	125	280	200	1400	610	480	230	940	550	75	26	1322	338,0
ENR 80-250	45	-	225M	80	100	125	280	225	1400	730	600	230	940	670	75	26	1429	397,0
ENR 80-250	55	-	250M	80	100	125	280	250	1600	660	530	270	1060	600	75	26	1429	431,0
ENR 80-250	75	-	280S	80	100	125	280	280	1800	730	600	300	1200	670	100	26	1559	565,0
ENR 80-315	-	5,5	132S	80	100	125	315	250	1120	610	480	190	740	550	50	22	1081	196,0
ENR 80-315	-	7,5	132M	80	100	125	315	250	1120	610	480	190	740	550	50	22	1081	204,0
ENR 80-315	-	11	160M	80	100	125	315	250	1400	610	480	230	940	550	75	26	1247	248,0
ENR 80-315	-	15	160L	80	100	125	315	250	1400	610	480	230	940	550	75	26	1247	262,0
ENR 80-315	-	18,5	180M	80	100	125	315	250	1400	610	480	230	940	550	75	26	1285	286,0
ENR 80-315	-	22	180L	80	100	125	315	250	1400	610	480	230	940	550	75	26	1322	325,0
ENR 80-315	-	30	200L	80	100	125	315	250	1400	730	600	230	940	670	75	26	1322	364,0

ELETTROPOMPE CENTRIFUGHE MONOBLOCCO SECONDO EN 733

in ghisa

DIMENSIONI ENR 80-100-125

Modello	Motore [kW]		Grand.	Dimensioni [mm]									Giunto standard					[kg]
	2 Poli	4 Poli		DN2	DN1	a	h2	h1	A	B	F	Y	V	E	H	S	T	
ENR 80-400	-	11	160M	80	125	125	355	280	1400	610	480	230	940	550	75	26	1307	356,0
ENR 80-400	-	15	160L	80	125	125	355	280	1400	610	480	230	940	550	75	26	1307	369,0
ENR 80-400	-	18,5	180M	80	125	125	355	280	1400	610	480	230	940	550	75	26	1345	392,0
ENR 80-400	-	22	180L	80	125	125	355	280	1400	610	480	230	940	550	75	26	1382	428,0
ENR 80-400	-	30	200L	80	125	125	355	280	1400	730	600	230	940	670	75	26	1382	452,0
ENR 100-160	-	2,2	100L	100	125	125	280	200	1120	610	480	190	740	550	50	22	999	155,0
ENR 100-160	-	3	100L	100	125	125	280	200	1120	610	480	190	740	550	50	22	999	155,0
ENR 100-160	-	4	112	100	125	125	280	200	1120	610	480	190	740	550	50	22	999	162,0
ENR 100-160	-	5,5	132S	100	125	125	280	200	1120	610	480	190	740	550	50	22	1081	173,0
ENR 100-160	18,5	-	160L	100	125	125	280	200	1400	610	480	230	940	550	75	26	1247	242,0
ENR 100-160	22	-	180M	100	125	125	280	200	1400	610	480	230	940	550	75	26	1285	266,0
ENR 100-160	30	-	200L	100	125	125	280	200	1400	610	480	230	940	550	75	26	1322	330,0
ENR 100-160	37	-	200L	100	125	125	280	200	1400	610	480	230	940	550	75	26	1322	330,0
ENR 100-200	-	2,2	100L	100	125	125	280	200	1120	610	480	190	740	550	50	22	999	159,0
ENR 100-200	-	3	100L	100	125	125	280	200	1120	610	480	190	740	550	50	22	999	159,0
ENR 100-200	-	4	112	100	125	125	280	200	1120	610	480	190	740	550	50	22	999	165,0
ENR 100-200	-	5,5	132S	100	125	125	280	200	1120	610	480	190	740	550	50	22	1081	176,0
ENR 100-200	-	7,5	132M	100	125	125	280	200	1120	610	480	190	740	550	50	22	1081	186,0
ENR 100-200	18,5	-	160L	100	125	125	280	200	1400	610	480	230	940	550	75	26	1247	245,0
ENR 100-200	22	-	180M	100	125	125	280	200	1400	610	480	230	940	550	75	26	1285	269,0
ENR 100-200	30	-	200L	100	125	125	280	200	1400	610	480	230	940	550	75	26	1322	333,0
ENR 100-200	37	-	200L	100	125	125	280	200	1400	610	480	230	940	550	75	26	1322	333,0
ENR 100-200	45	-	225M	100	125	125	280	225	1400	730	600	230	940	670	75	26	1429	392,0
ENR 100-200	75	-	280S	100	125	125	280	280	1800	730	600	300	1200	670	100	26	1559	560,0
ENR 100-250	-	4	112	100	125	140	280	225	1120	610	480	190	740	550	50	22	1014	190,0
ENR 100-250	-	5,5	132S	100	125	140	280	225	1120	610	480	190	740	550	50	22	1096	201,0
ENR 100-250	-	7,5	132M	100	125	140	280	225	1120	610	480	190	740	550	50	22	1096	209,0
ENR 100-250	-	11	160M	100	125	140	280	225	1400	610	480	230	940	550	75	26	1262	252,0
ENR 100-250	-	15	160L	100	125	140	280	225	1400	610	480	230	940	550	75	26	1262	266,0
ENR 100-250	30	-	200L	100	125	140	280	225	1400	730	600	230	940	670	75	26	1337	368,0
ENR 100-250	37	-	200L	100	125	140	280	225	1400	730	600	230	940	670	75	26	1337	368,0
ENR 100-250	45	-	225M	100	125	140	280	225	1600	660	530	270	1060	600	75	26	1444	417,0
ENR 100-250	55	-	250M	100	125	140	280	250	1600	660	530	270	1060	600	75	26	1444	447,0
ENR 100-250	75	-	280S	100	125	140	280	280	1800	730	600	300	1200	670	100	26	1574	581,0
ENR 100-250	90	-	280M	100	125	140	280	280	1800	730	600	300	1200	670	100	26	1574	627,0
ENR 100-315	-	11	160M	100	125	140	315	250	1400	610	480	230	940	550	75	26	1262	270,0
ENR 100-315	-	15	160L	100	125	140	315	250	1400	610	480	230	940	550	75	26	1262	284,0
ENR 100-315	-	18,5	180M	100	125	140	315	250	1400	610	480	230	940	550	75	26	1300	309,0
ENR 100-315	-	22	180L	100	125	140	315	250	1400	610	480	230	940	550	75	26	1337	347,0
ENR 100-315	-	30	200L	100	125	140	315	250	1400	730	600	230	940	670	75	26	1337	386,0
ENR 100-400	-	15	160L	100	125	140	355	280	1400	730	600	230	940	670	75	26	1322	373,0
ENR 100-400	-	18,5	180M	100	125	140	355	280	1400	730	600	230	940	670	75	26	1360	398,0
ENR 100-400	-	22	180L	100	125	140	355	280	1400	730	600	230	940	670	75	26	1397	436,0
ENR 100-400	-	30	200L	100	125	140	355	280	1400	730	600	230	940	670	75	26	1397	462,0
ENR 100-400	-	37	225S	100	125	140	355	280	1400	730	600	230	940	670	75	26	1504	503,0
ENR 100-400	-	45	225M	100	125	140	355	280	1400	730	600	230	940	670	75	26	1504	521,0
ENR 125-200	-	7,5	132M	125	150	140	315	250	1120	610	480	190	740	550	50	22	1096	223,0
ENR 125-200	-	11	160M	125	150	140	315	250	1400	610	480	230	940	550	75	26	1262	267,0
ENR 125-200	-	15	160L	125	150	140	315	250	1400	610	480	230	940	550	75	26	1262	281,0
ENR 125-200	37	-	200L	125	150	140	315	250	1400	730	600	230	940	670	75	26	1337	383,0
ENR 125-200	45	-	225M	125	150	140	315	250	1600	660	530	270	1060	600	75	26	1444	432,0
ENR 125-200	55	-	250M	125	150	140	315	250	1600	660	530	270	1060	600	75	26	1444	462,0
ENR 125-200	75	-	280S	125	150	140	315	280	1800	730	600	300	1200	670	100	26	1574	595,0
ENR 125-200	90	-	280M	125	150	140	315	280	1800	730	600	300	1200	670	100	26	1574	641,0
ENR 125-200	110	-	315S	125	150	140	315	315	1800	850	700	300	1200	780	100	26	1574	670,0
ENR 125-250	-	7,5	132M	125	150	140	355	250	1120	610	480	190	740	550	50	22	1096	237,0
ENR 125-250	-	11	160M	125	150	140	355	250	1400	610	480	230	940	550	75	26	1262	281,0
ENR 125-250	-	15	160L	125	150	140	355	250	1400	610	480	230	940	550	75	26	1262	295,0
ENR 125-250	-	18,5	180M	125	150	140	355	250	1400	610	480	230	940	550	75	26	1300	319,0
ENR 125-250	-	22	180L	125	150	140	355	250	1400	610	480	230	940	550	75	26	1337	358,0

ELETTROPOMPE CENTRIFUGHE MONOBLOCCO SECONDO EN 733

in ghisa

DIMENSIONI ENR 125-150-200

Modello	Motore		Dimensioni [mm]											[kg]			
	[kW] 4 Poli	Grand.	DN2	DN1	a	h2	h1	A	B	F	Y	Giunto standard					
												V	E	H	S	T	
ENR 125-315	15	160L	125	150	140	355	280	1400	730	600	230	940	670	75	26	1322	352,0
ENR 125-315	18,5	180M	125	150	140	355	280	1400	730	600	230	940	670	75	26	1360	377,0
ENR 125-315	22	180L	125	150	140	355	280	1400	730	600	230	940	670	75	26	1397	415,0
ENR 125-315	30	200L	125	150	140	355	280	1400	730	600	230	940	670	75	26	1397	440,0
ENR 125-315	37	225S	125	150	140	355	280	1400	730	600	230	940	670	75	26	1504	482,0
ENR 125-400	30	200L	125	150	140	400	315	1400	730	600	230	940	670	75	26	1397	475,0
ENR 125-400	37	225S	125	150	140	400	315	1400	730	600	230	940	670	75	26	1504	516,0
ENR 125-400	45	225M	125	150	140	400	315	1400	730	600	230	940	670	75	26	1504	534,0
ENR 125-400	55	250M	125	150	140	400	315	1800	730	600	300	1200	670	100	26	1569	612,0
ENR 125-400	75	280S	125	150	140	400	315	1800	850	700	300	1200	780	100	26	1634	733,0
ENR 150-200	7,5	132M	150	200	160	400	280	1400	730	600	230	940	670	75	26	1116	303,0
ENR 150-200	11	160M	150	200	160	400	280	1400	730	600	230	940	670	75	26	1282	325,0
ENR 150-200	15	160L	150	200	160	400	280	1400	730	600	230	940	670	75	26	1282	338,0
ENR 150-200	18,5	180M	150	200	160	400	280	1400	730	600	230	940	670	75	26	1320	363,0
ENR 150-250	15	160L	150	200	160	400	280	1400	730	600	230	940	670	75	26	1282	370,0
ENR 150-250	18,5	180M	150	200	160	400	280	1400	730	600	230	940	670	75	26	1320	395,0
ENR 150-250	22	180L	150	200	160	400	280	1400	730	600	230	940	670	75	26	1357	433,0
ENR 150-250	30	200L	150	200	160	400	280	1400	730	600	230	940	670	75	26	1357	459,0
ENR 150-250	37	225S	150	200	160	400	280	1400	730	600	230	940	670	75	26	1464	500,0
ENR 150-315	18,5	180M	150	200	160	400	280	1400	730	600	230	940	670	75	26	1380	427,0
ENR 150-315	22	180L	150	200	160	400	280	1400	730	600	230	940	670	75	26	1417	465,0
ENR 150-315	30	200L	150	200	160	400	280	1400	730	600	230	940	670	75	26	1417	491,0
ENR 150-315	37	225S	150	200	160	400	280	1800	730	600	300	1200	670	100	26	1524	567,0
ENR 150-315	45	225M	150	200	160	400	280	1800	730	600	300	1200	670	100	26	1524	586,0
ENR 150-315	55	250M	150	200	160	400	280	1800	730	600	300	1200	670	100	26	1589	628,0
ENR 150-400	45	225M	150	200	160	450	315	1800	730	600	300	1200	670	100	26	1524	605,0
ENR 150-400	55	250M	150	200	160	450	315	1800	730	600	300	1200	670	100	26	1589	647,0
ENR 150-400	75	280S	150	200	160	450	315	1800	850	700	300	1200	780	100	26	1654	768,0
ENR 150-400	90	280M	150	200	160	450	315	1800	850	700	300	1200	780	100	26	1654	837,0
ENR 200-250	15	160L	200	200	160	400	280	1400	730	600	230	940	670	75	26	1402	425,0
ENR 200-250	18,5	180M	200	200	160	400	280	1400	730	600	230	940	670	75	26	1440	450,0
ENR 200-250	22	180L	200	200	160	400	280	1400	730	600	230	940	670	75	26	1477	488,0
ENR 200-250	30	200L	200	200	160	400	280	1400	730	600	230	940	670	75	26	1477	514,0

ELETTROPOMPE CENTRIFUGHE MONOBLOCCO SECONDO EN 733

in ghisa

DIMENSIONI ENR solo pompa



TABELLA DIMENSIONI

Modello	Supp.	Dimensioni [mm]																			Peso [kg]	
		Pompa						Piede						Sporgenza d'albero								
DN2	DN1	a	f	h2	h1	b	c	m1	m2	n1	n2	s1	s2	w	x	d1	l	t	u			
ENR 32-125	25	32	50	80	360	112	140	50	15	100	70	190	140	M12	M12	260	100	24	50	27	8	31,0
ENR 32-160	25	32	50	80	360	132	160	50	15	100	70	240	190	M12	M12	260	100	24	50	27	8	33,0
ENR 32-200	25	32	50	80	360	160	180	50	15	100	70	240	190	M12	M12	260	100	24	50	27	8	34,0
ENR 32-250	25	32	50	100	360	180	225	65	15	125	95	320	250	M12	M12	260	100	24	50	27	8	46,0
ENR 40-125	25	40	65	80	360	112	140	50	15	100	70	210	160	M12	M12	260	100	24	50	27	8	28,0
ENR 40-160	25	40	65	80	360	132	160	50	15	100	70	240	190	M12	M12	260	100	24	50	27	8	30,0
ENR 40-200	25	40	65	100	360	160	180	50	15	100	70	265	212	M12	M12	260	100	24	50	27	8	36,0
ENR 40-250	25	40	65	100	360	180	225	65	15	125	95	320	250	M12	M12	260	100	24	50	27	8	46,0
ENR 40-315	35	40	65	125	470	225	250	65	18	125	95	345	280	M12	M12	340	100	32	80	35	10	73,0
ENR 50-125	25	50	65	100	360	132	160	50	15	100	70	240	190	M12	M12	260	100	24	50	27	8	30,0
ENR 50-160	25	50	65	100	360	160	180	50	15	100	70	265	212	M12	M12	260	100	24	50	27	8	36,0
ENR 50-200	25	50	65	100	360	160	200	50	15	100	70	265	212	M12	M12	260	100	24	50	27	8	40,0
ENR 50-250	25	50	65	100	360	180	225	65	15	125	95	320	250	M12	M12	260	100	24	50	27	8	50,0
ENR 50-315	35	50	65	125	470	225	280	65	17	125	95	345	280	M12	M12	340	100	32	80	35	10	88,0
ENR 65-125	25	65	80	100	360	160	180	65	15	125	95	280	212	M12	M12	260	100	24	50	27	8	33,0
ENR 65-160	25	65	80	100	360	160	200	65	15	125	95	280	212	M12	M12	260	100	24	50	27	8	39,0
ENR 65-200	25	65	80	100	360	180	225	65	15	125	95	320	250	M12	M12	260	140	24	50	27	8	45,0
ENR 65-250	35	65	80	100	470	200	250	80	15	160	120	360	280	M16	M12	340	140	32	80	35	10	70,0
ENR 65-315	35	65	80	125	470	225	280	80	18	160	120	400	315	M16	M12	340	140	32	80	35	10	92,0
ENR 80-160	25	80	100	125	360	180	225	65	15	125	95	320	250	M12	M12	260	140	24	50	27	8	43,0
ENR 80-200	35	80	100	125	470	180	250	65	15	125	95	345	280	M12	M12	340	140	32	80	35	10	60,0
ENR 80-250	35	80	100	125	470	200	280	80	18	160	120	400	315	M16	M12	340	140	32	80	35	10	75,0
ENR 80-315	35	80	100	125	470	250	315	80	18	160	120	400	315	M16	M12	340	140	32	80	35	10	95,0
ENR 80-400	45	80	125	125	530	280	355	80	18	160	120	435	355	M16	M12	370	140	42	110	45	12	143,0
ENR 100-160	35	100	125	125	470	200	280	80	18	160	120	360	280	M16	M12	340	140	32	80	35	10	78,0
ENR 100-200	35	100	125	125	470	200	280	80	18	160	120	360	280	M16	M12	340	140	32	80	35	10	70,0
ENR 100-250	35	100	125	140	470	225	280	80	18	160	120	400	315	M16	M12	340	140	32	80	35	10	85,0
ENR 100-315	35	100	125	140	470	250	315	80	18	160	120	400	315	M16	M12	340	140	32	80	35	10	104,0
ENR 100-400	45	100	125	140	530	280	355	100	18	200	150	500	400	M20	M12	370	140	42	110	45	12	177,0
ENR 125-200	35	125	150	140	470	250	315	80	18	160	120	400	315	M16	M12	340	140	32	80	35	10	100,0
ENR 125-250	35	125	150	140	470	250	355	80	18	160	120	400	315	M16	M12	340	140	32	80	35	10	102,0
ENR 125-315	45	125	150	140	530	280	355	100	18	200	150	500	400	M20	M12	370	140	42	110	45	12	151,0
ENR 125-400	45	125	150	140	530	315	400	100	18	200	150	500	400	M20	M12	370	140	42	110	45	12	188,0
ENR 150-200	35	150	200	160	470	280	400	100	20	200	150	550	450	M20	M12	340	140	32	80	35	10	123,0
ENR 150-250	35	150	200	160	470	280	400	100	20	200	150	500	400	M20	M12	340	140	32	80	35	10	128,0
ENR 150-315	45	150	200	160	530	280	400	100	18	200	150	550	450	M20	M12	370	140	42	110	45	12	170,0
ENR 150-400	45	150	200	160	530	315	450	100	18	200	150	550	450	M20	M12	370	140	42	110	45	12	205,0
ENR 200-250	45	200	200	160	590	280	400	100	22	200	150	500	400	M20	M12	430	180	42	110	45	12	230,0

ELETTROPOMPE CENTRIFUGHE MONOBLOCCO SECONDO EN 733

in ghisa

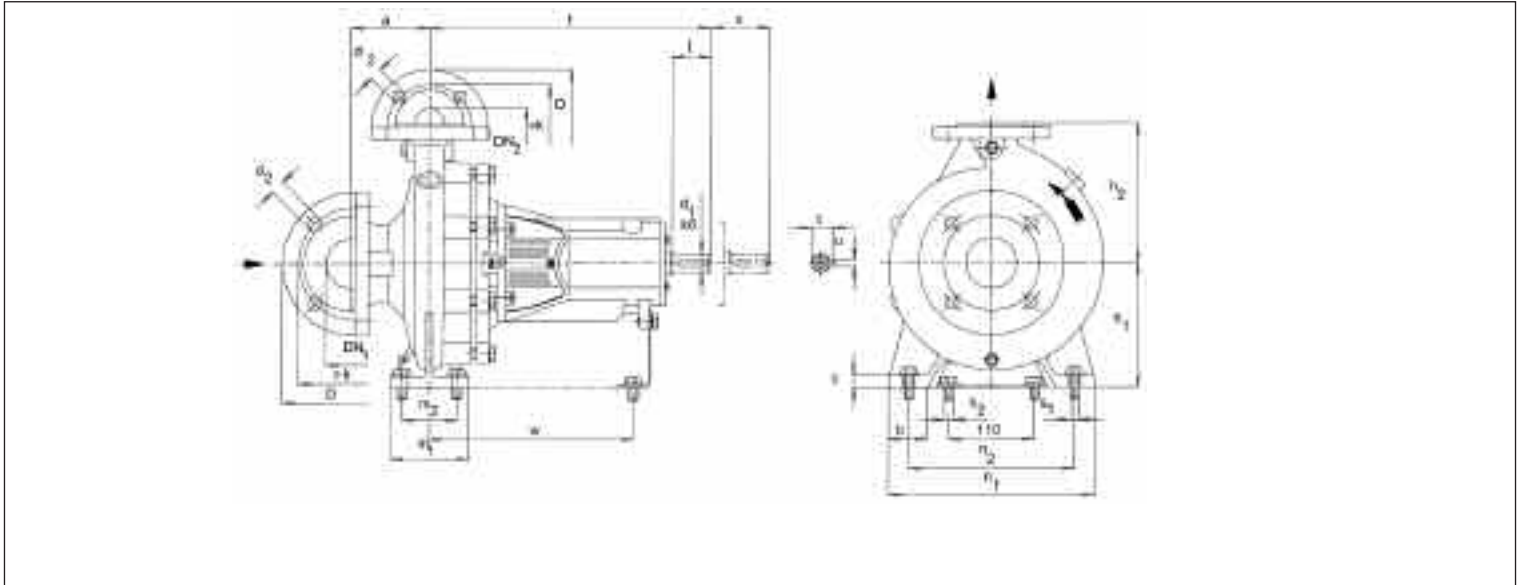
VISTA IN SEZIONE 25-32-45



TABELLA COMPONENTI

Rif.	Nome
10.20	Corpo pompa
16.10	Disco porta tenuta
18.30	Supporto piede
21.00	Albero
23.00	Girante
32.10	Cuscinetto
33.00	Supporto cuscinetto
43.30	Tenuta meccanica

VISTA IN SEZIONE 55 - 65

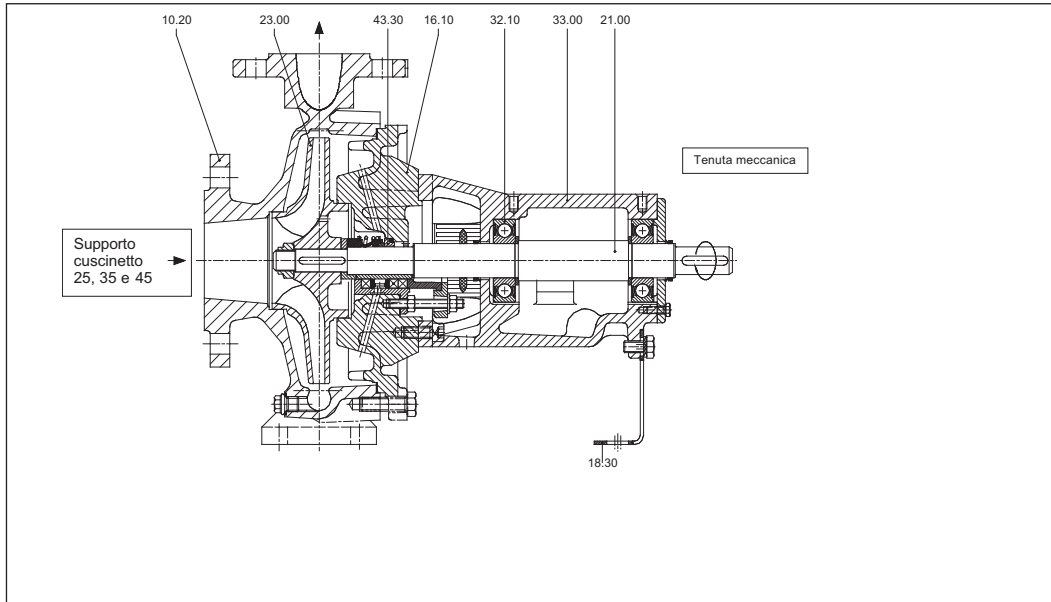
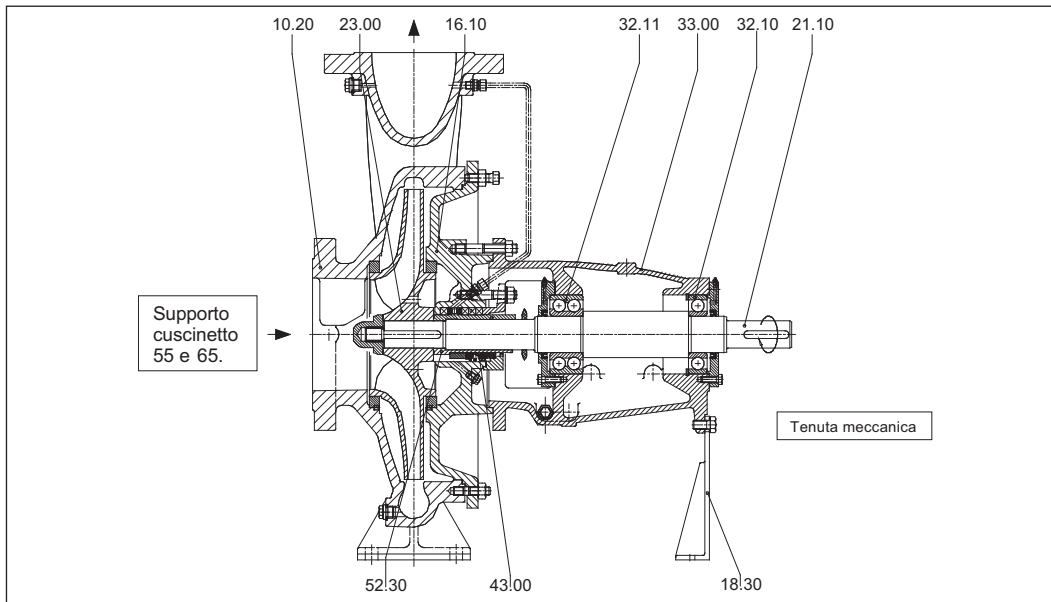

TABELLA COMPONENTI

Rif.	Nome
10.20	Corpo pompa
16.10	Disco porta tenuta
18.30	Supporto piede
21.00	Albero
23.00	Girante
32.10	Cuscinetto
32.11	Cuscinetto
33.00	Supporto cuscinetto
43.30	Tenuta meccanica
52.30	Camicia d'albero (tenuta meccanica)